

轨道交通上的应用

售票机



地铁闸机



屏蔽门

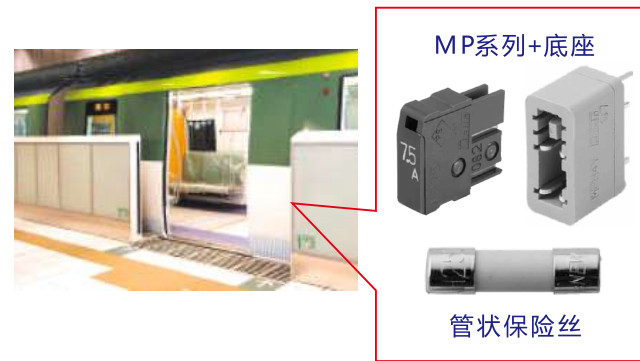

主控器

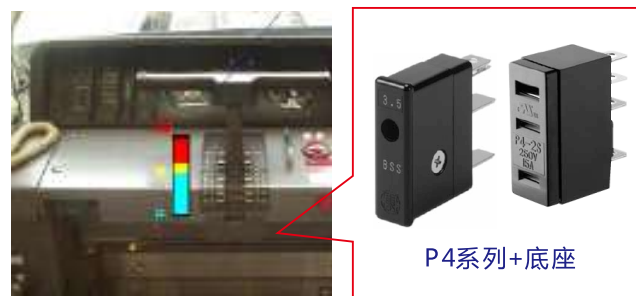

风扇单元

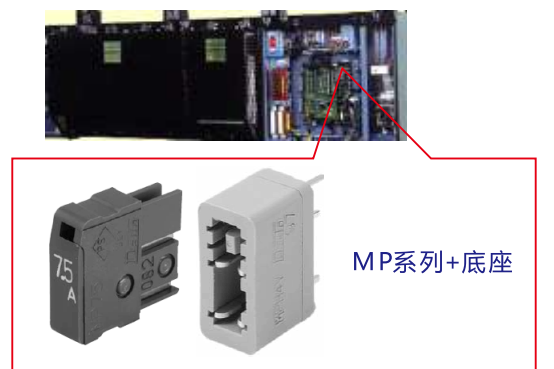

车门

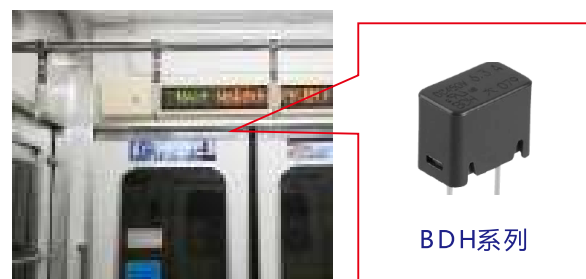

摇动制动器

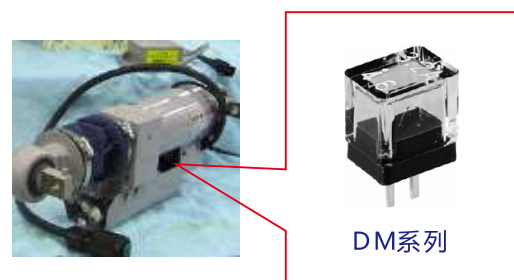

速度计

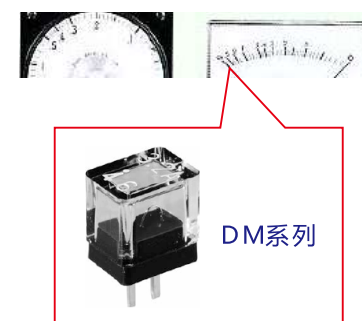

产品应用领域

通信设备

移动电话基站



(HO-IBS) 无线装置用中间电流装置

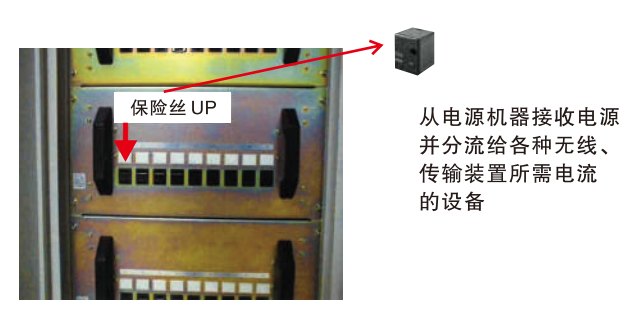

直流配电盘

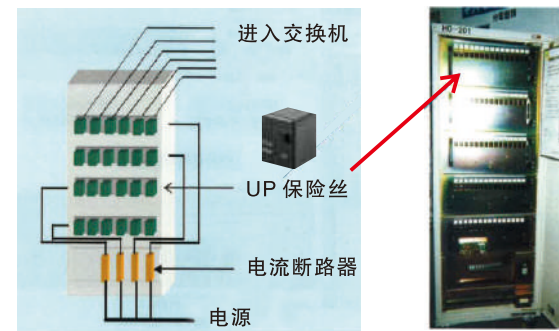

新型局用交换机

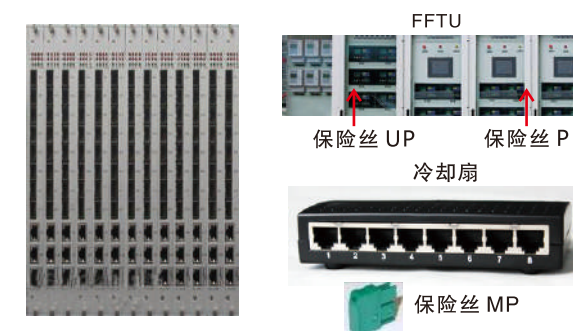

工业设备

机械手 & 射出成形机



工业机器控制室

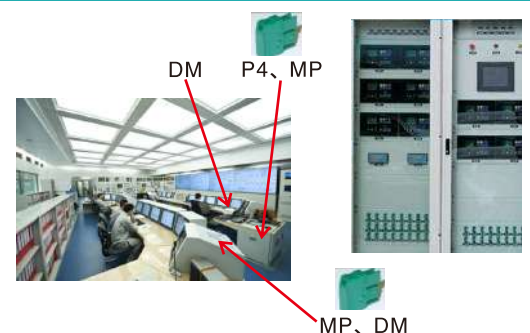

代理品牌 注：按品牌首字母排名



创意电子有限公司 Weltronics Component Limited

创意香港 电话:(852)24100623 传真:(852)24100920

创意深圳 (755)83480330 (755)83480105

创意广州 (020)83511853 (020)83511491

创意北京 (010)62982798 (010)62980880

创意上海 (021)60952881 (021)60952882

注：查询其他办联系方式请登录公司网址 了解更多信息

Daito

警报式保险丝



熔断+警报，
为产品的安全性加多一重保障

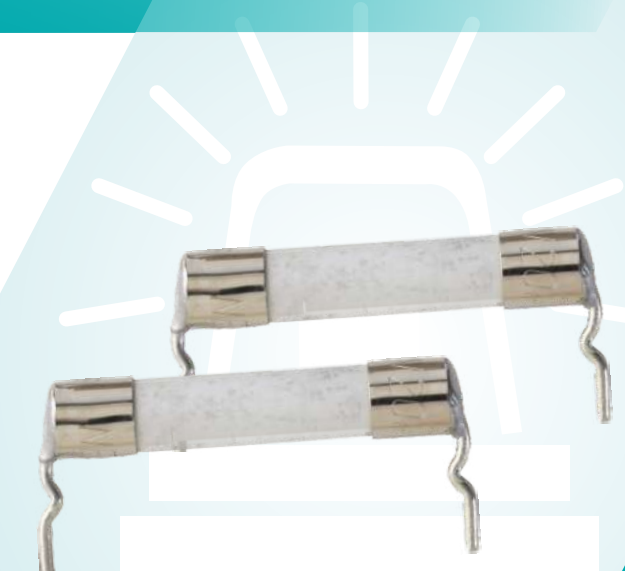

信息咨询: www.weltronics.com

现货销售: www.wclbuy.com



创意电子有限公司
Weltronics Component Limited



警报式保险丝

警报式保险丝在保险丝熔断时显示，并通过内部接点输出警报，将无人值守区域设备的保险丝熔断信息传递给联络中心。保险丝熔断后为白色，因此很容易识别。我们配有形状易抓握的专用保险丝座，拆装方便快捷。

警报专用保险丝是一种能够长年使用且可靠性很高的保险丝，用于对可靠性要求高的设备上，如各种通信设备，机床等各种工业设备，核电站等的工厂控制设备等。

警报专用保险丝的功能与特性

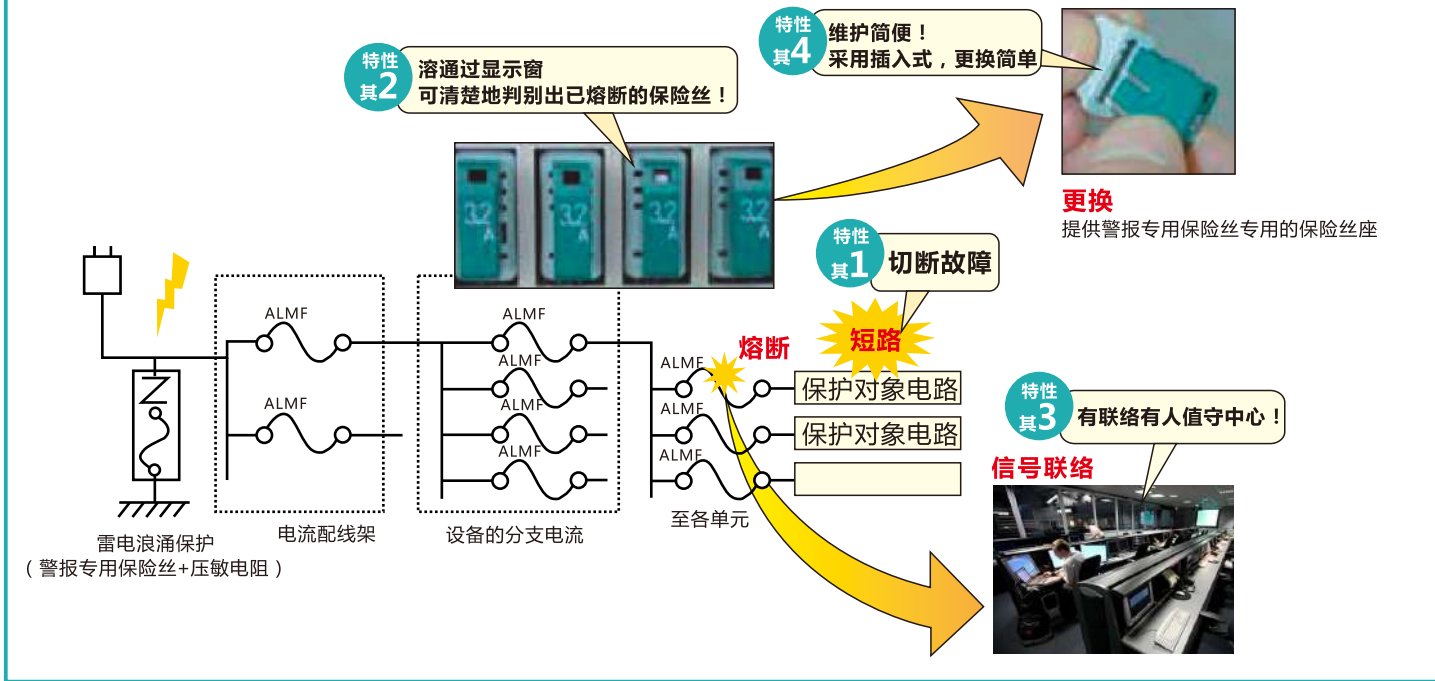

工作原理:

- 一个产品，实现双重功能（回路保护和保险丝熔断信息的传达）
- 一目了然，更换方便（白色溶断可可视，可拆卸式）
- 利用内部报警接点，将熔断信息传递给远程控制中心

警报专用保险丝也可用于防雷

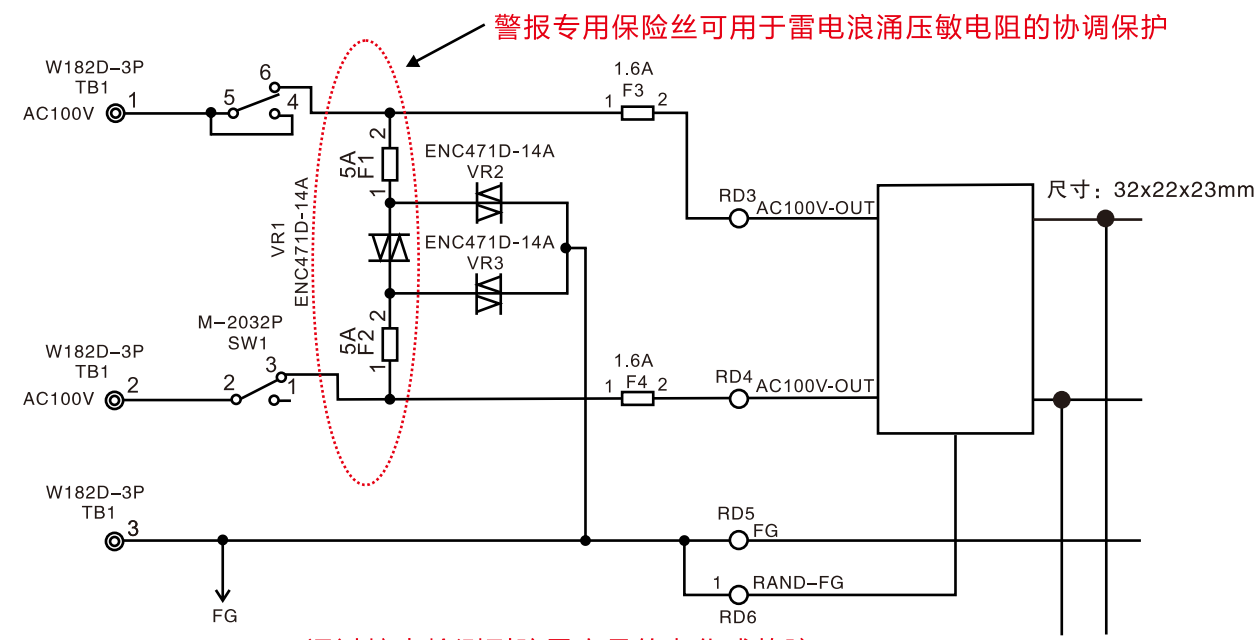

保险丝在汽车中的应用

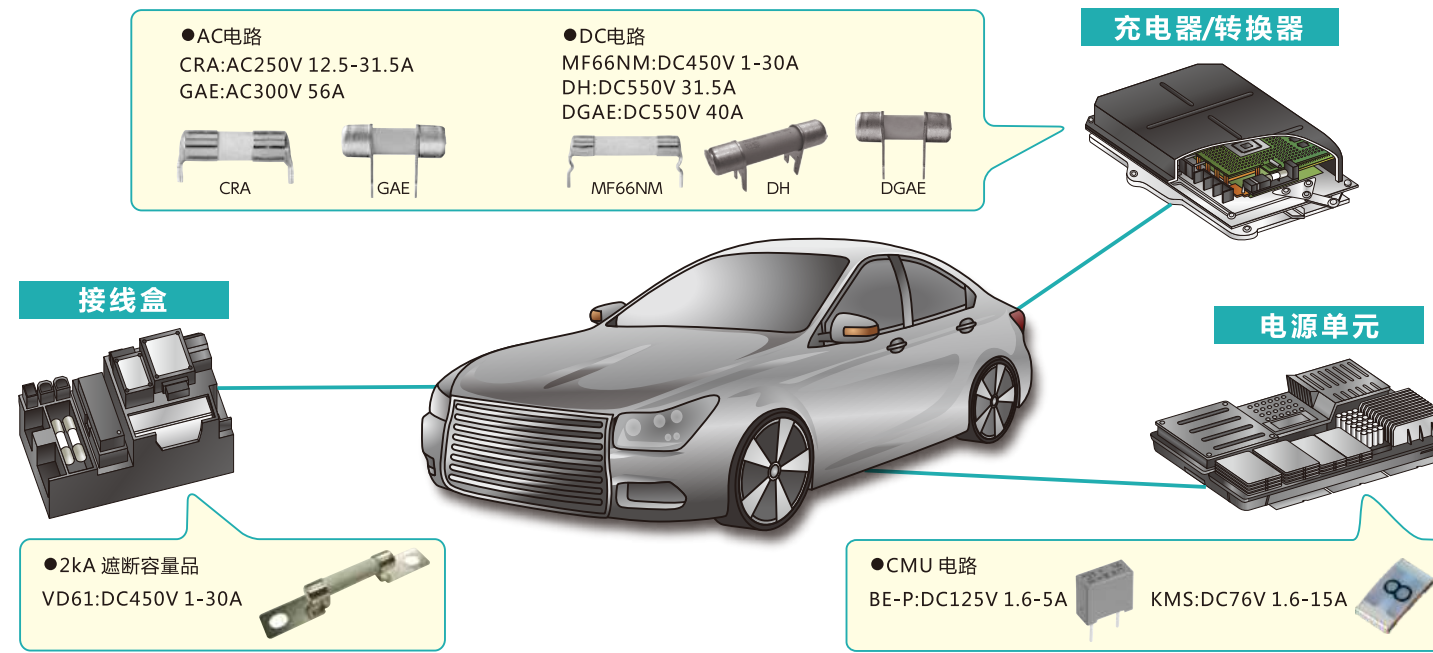

产品列表

系列名称	图片	尺寸	额定电压	额定电流	熔断电流	标准认证	备注
CM fuse		7.5×4.2×2.7mm	AC48V/DC76V	0.4~5A	50A/100A	UL, PSE	
KMS fuse		3.2×1.6×0.7mm	DC76V	1.6~15A	50A	UL, PSE	
CRA fuse		φ6.35×20mm	AC250V	12.5~31.5A	500A	UL, PSE	
RD fuse		12.5×7.5×8.5mm	DC76V	5~20A	500A	UL, PSE	
BE-P fuse		9×4×8mm	AC/DC125V	1.6~5A	50A	UL, PSE	
MF66NM/MF67NM fuse		φ6.35×31.8mm	DC650V DC450V	1~8A 10~30A	150A 400A	UL, PSE	
D51/D52 fuse		φ5.2×20mm	DC450V	1~10A	400A	UL, PSE	
D61/D62 fuse		φ6.35×20mm	DC450V	10~20A	400A	UL, PSE	New product
HDGAC fuse		φ10.5×39mm	DC1000V	16A	1,000A/500A	UL, PSE	New product
FCRA fuse		φ6.7×20mm	AC250V	30A	500A	UL, PSE	New product
GAE fuse		φ10.5×32mm	AC300V	56A	1,500A	UL, PSE	New product
VD61 fuse		φ6.35×31.8mm Bolt-fixing type	DC450V	1A, 30A	2,000A	UL, PSE (30A only)	New product
DGAR fuse (fast-blow)		φ10.5×39mm	DC450V	25A 35.5A	5,000A 10,000A		New product
HRP fuse		20×5×30mm	DC120V	175A	2,000A		Development item
DH fuse		φ6.35×25mm	DC550V	31.5A	1,000A		Development item
DGAE fuse		φ10.5×32mm	DC550V	40A	1,000A		Development item

* Please feel free to contact us for more detailed information about the variation of the rated currents and the terminal shapes of tubular fuses.
* Refer overleaf for application examples. *The specifications for development items are subject to change without prior notice.

商用空调回路上的应用

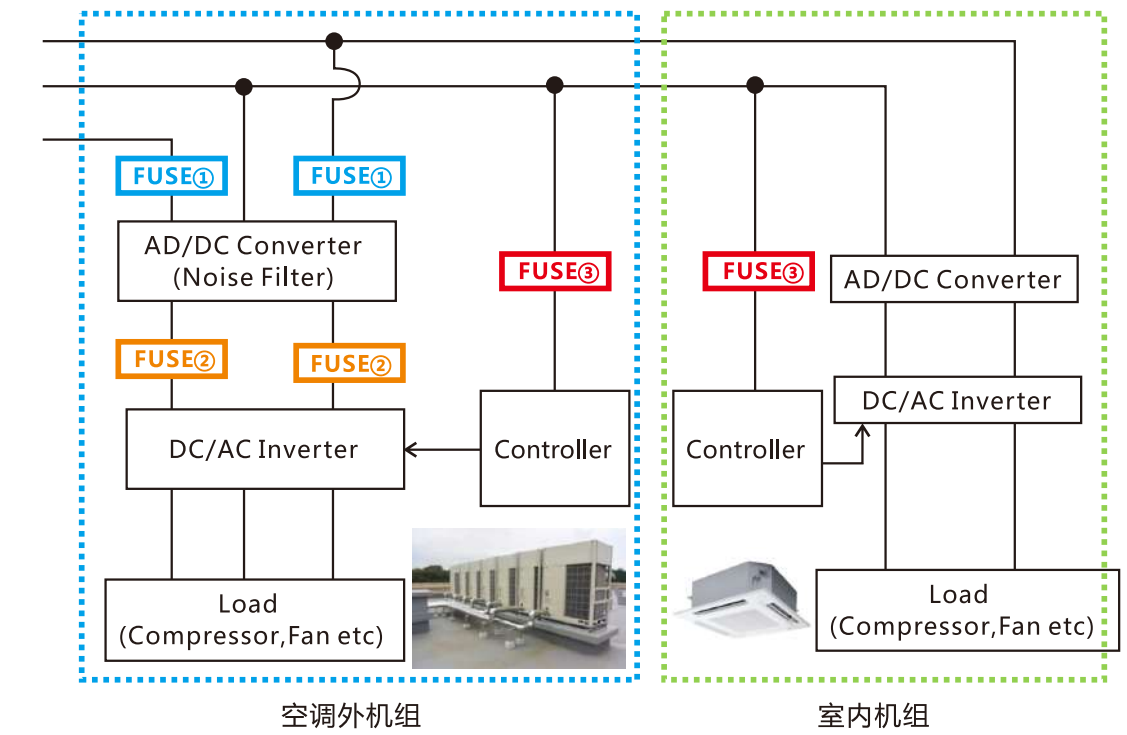

FUSE① AC/DC转换器 (噪音过滤器)

HC 尺寸: φ6.35x31.8mm 额定电压: AC250V 额定电流: 30A 安全认证: UL, PSE		VA101系列 尺寸: φ10.3x39mm 额定电压: AC500V(40A) AC250V(70A) 额定电流: 40A, 70A 安全认证: UL		GAC系列 尺寸: φ10.5x39mm 额定电压: AC500V(25~40A) AC250V(50~80A) 额定电流: 25~80A 安全认证: UL, PSE	
LAC系列 尺寸: φ14.3x39mm 额定电压: AC600V(40, 63A) AC250V(100~125A) 额定电流: 40, 63, 100, 125A 安全认证: UL, PSE		UAC 尺寸: φ20.9x41mm 额定电压: AC250V 额定电流: 200A 安全认证: UL, PSE			

FUSE② DC/AC逆变器

D51系列 尺寸: φ5.2x20mm 额定电压: DC450V(1~10A) 额定电流: 1~10A 安全认证: UL		MF66NM系列 尺寸: φ6.35x31.8mm 额定电压: DC650V(1~8A) DC450V(10~30A) 额定电流: 1~30A 安全认证: UL	
--	--	---	--

FUSE③ 控制器

KMS系列 尺寸: 3.2x1.6x0.7mm (SMD型) 额定电压: DC76V 额定电流: 1.6~15A 安全认证: UL		LM系列 (黑色/透明色) 尺寸: 10x4x8mm 额定电压: DC48V 额定电流: 0.3~5A 安全认证: UL, TUV	
---	--	---	--