

警报式保险丝

警报式保险丝在保险丝熔断时显示，并通过内部接点输出警报，将无人值守区域设备的保险丝熔断信息传递给联络中心。保险丝熔断后为白色，因此很容易识别。我们配有形状易抓握的专用保险丝座，拆装方便快捷。

警报专用保险丝是一种能够长年使用且可靠性很高的保险丝，用于对可靠性要求高的各类设备上，如通信设备，工业设备（机床，工厂控制设备），核电站等。

警报专用保险丝的功能与特性

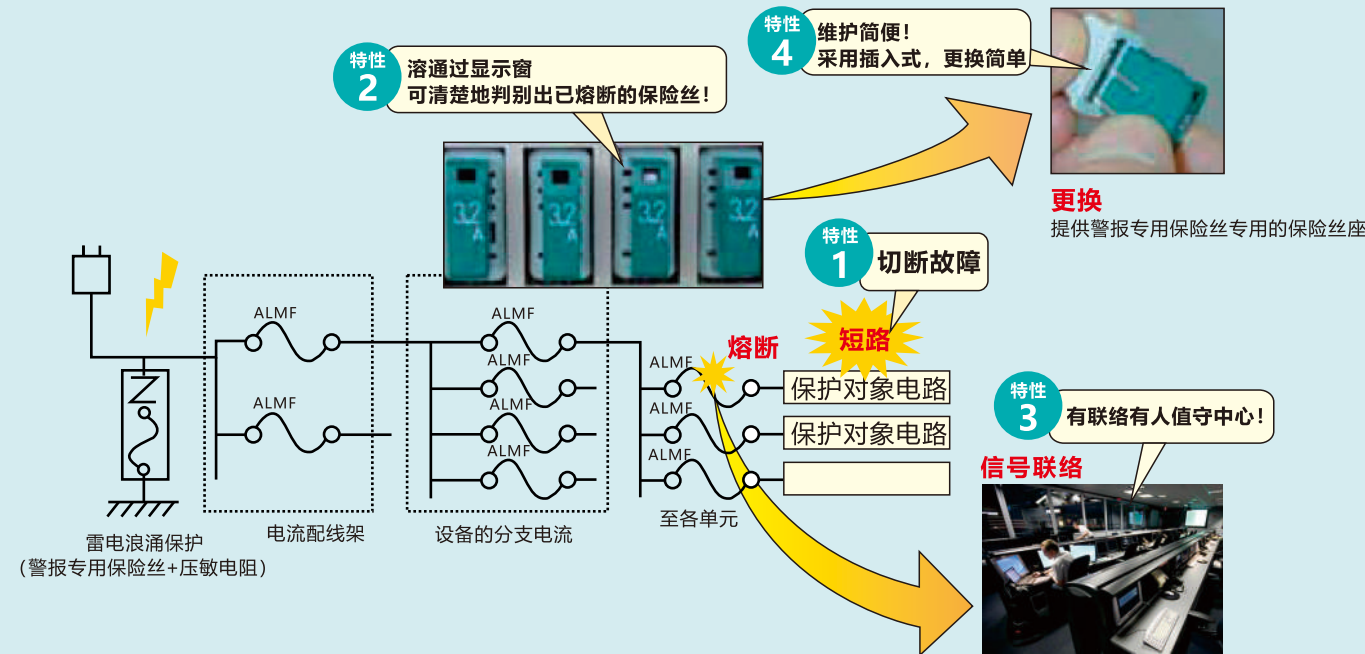

工作原理:

- 一个产品，实现双重功能（回路保护和保险丝熔断信息的传达）
- 一目了然，更换方便（白色熔断可可视，可拆卸式）
- 利用内部报警接点，将熔断信息传送给远程控制中心

警报专用保险丝也可用于防雷

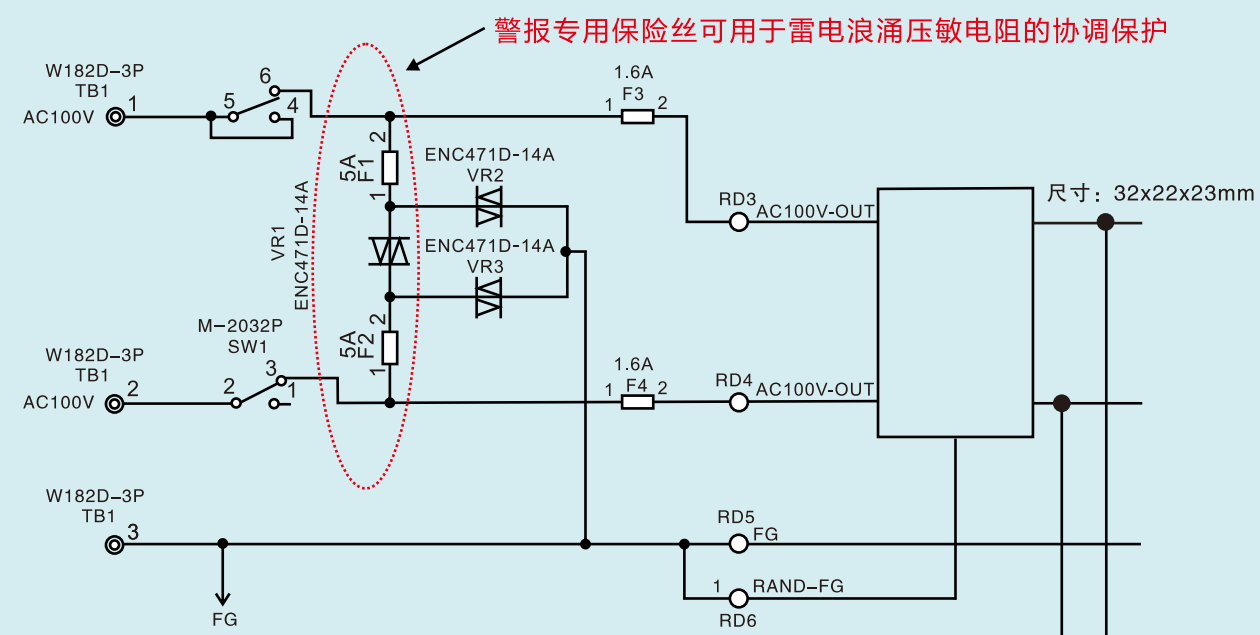

通信及工业设备应用

移动电话基站



(HO-IBS) 无线装置用中间电流装置

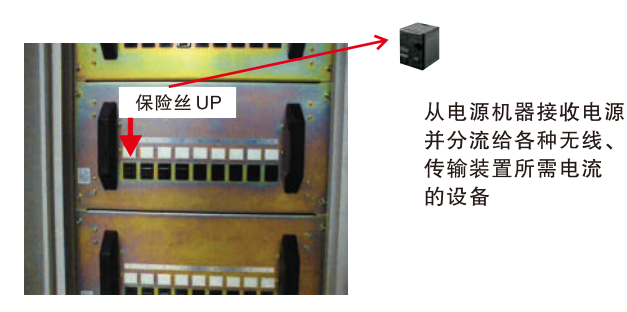

直流配电盘

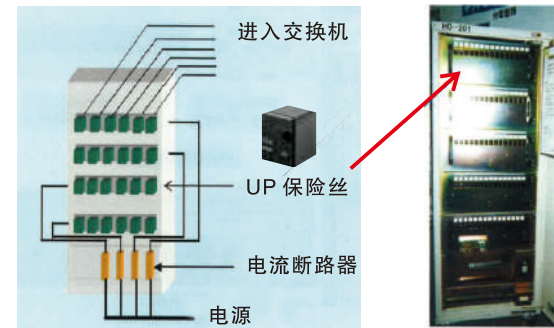

新型局用交换机

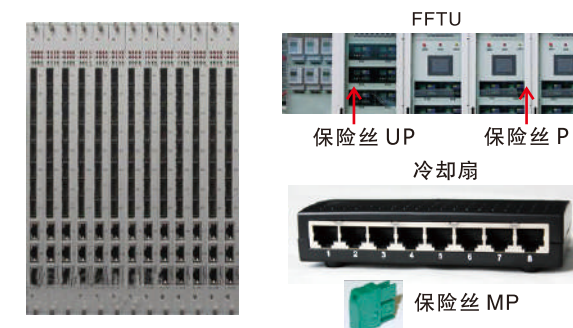

机械手 & 射出成形机



工业机器 控制室

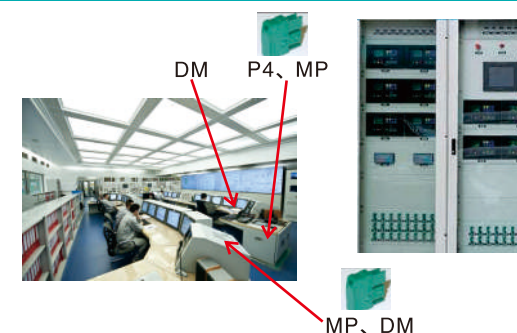

代理品牌

注: 按品牌首字母排名



创意香港 电话: (852)24100623 传真: (852)24100920
 创意深圳 电话: (755)83480330 传真: (755)83480105
 创意广州 电话: (020)83511853 传真: (020)83511491
 创意北京 电话: (010)62982798 传真: (010)62980880
 创意上海 电话: (021)60952881 传真: (021)60952882

其他办事处联系方式请至: www.weltronics.com 咨询建议请至: market@weltronics.com

Daito

警报式保险丝

熔断+警报
只为产品使用更安全



由代理商创意电子为您提供技术支持

信息查询: www.weltronics.com
 现货销售: www.wclbuy.com

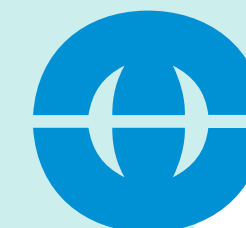

创意电子有限公司
 Weltronics Component Limited

保险丝在汽车中的应用

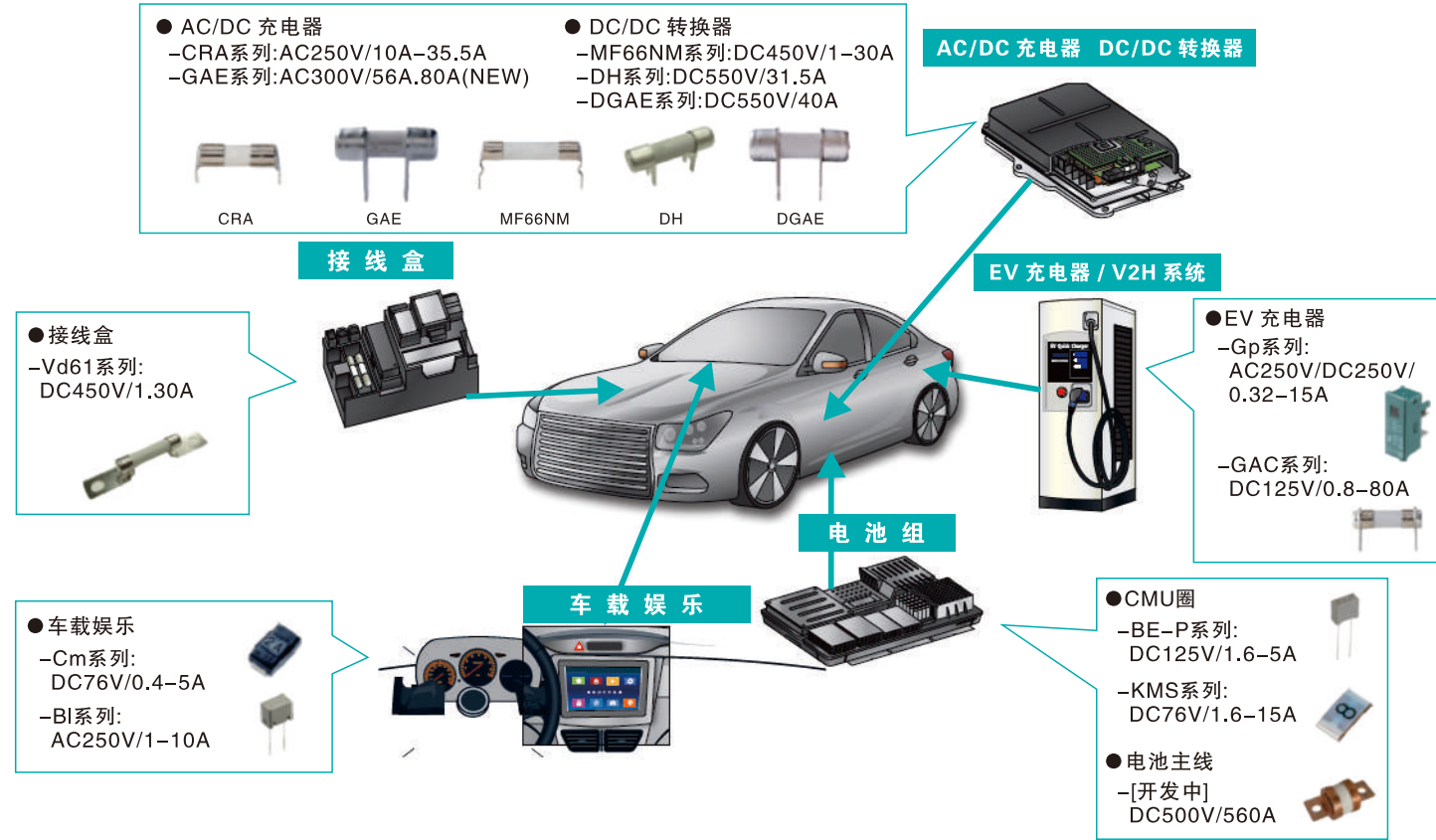

产品列表

系列名称	图片	尺寸	额定电压	额定电流	熔断电流	标准认证
CM fuse		7.5x4.2x2.7mm	AC48V/DC76V	0.4~5A	50A/100A	UL, PSE
KMS fuse		3.2x1.6x0.7mm	DC76V	1.6~15A	50A	UL, PSE
CRA fuse		φ6.35x20mm	AC250V	12.5~31.5A	500A	UL, PSE, VDE
RD fuse		12.5x7.5x8.5mm	DC76V	5~20A	500A	UL, PSE
BE-P fuse		9x4x8mm	AC/DC125V	1.6~5A	50A	UL, PSE, VDE
MF66NM/67NM fuse		φ6.35x31.8mm	DC650V DC450V	1~8A 10~30A	150A 400A	UL, PSE
D51/D52 fuse		φ5.2x20mm	DC450V	1~10A	400A	UL, PSE
D61/D62 fuse		φ6.35x20mm	DC450V	10~20A	400A	UL, PSE
HDGAC fuse		φ10.5x39mm	DC1000V	16A	1,000A/500A	UL, PSE
FCRA fuse		φ6.7x20mm	AC250V	30A	500A	UL, PSE
GAE fuse		φ10.5x32mm	AC300V	56A	1,500A	UL, PSE, VDE
VD61 fuse		φ6.35x31.8mm Bolt-fixing type	DC450V	1A,30A	2,000A	UL, PSE (30A only)
DGAR fuse(fast-blow)		φ10.5x39mm	DC450V	25A 35.5A	5,000A 10,000A	
HRP fuse		20x5x30mm	DC120V	175A	2,000A	
DH fuse		φ6.35x25mm	DC550V	31.5A	1,000A	
DGAE fuse		φ10.5x32mm	DC550V	40A	1,000A	

* Please feel free to contact us for more detailed information about the variation of the rated currents and the terminal shapes of tubular fuses.
* Refer overleaf for application examples. **The specifications for development items are subject to change without prior notice.

商用空调回路上的应用

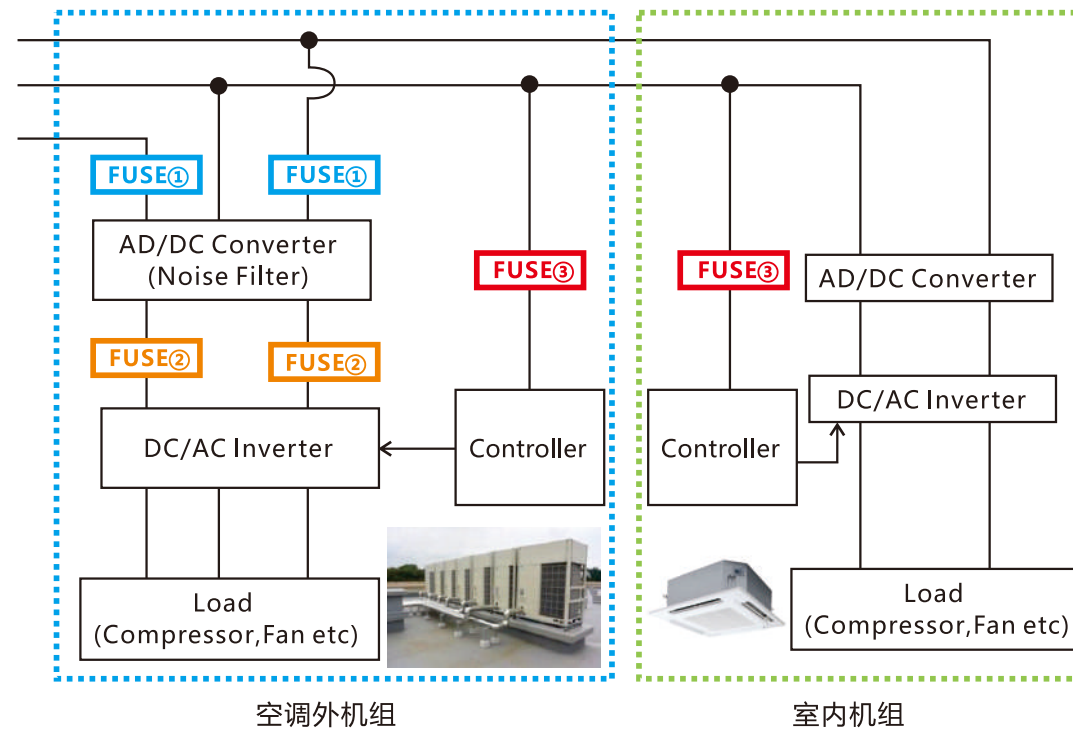

FUSE① AC/DC 转换器 (噪音过滤器)

HC
尺寸: φ6.35x31.8mm
额定电压: AC250V
额定电流: 30A
安全认证: UL, PSE



VA101 系列
尺寸: φ10.3x39mm
额定电压: AC500V(40A)
AC250V(70A)
额定电流: 40A, 70A
安全认证: UL



GAC 系列
尺寸: φ10.5x39mm
额定电压: AC500V(25~40A)
AC250V(50~80A)
额定电流: 25~80A
安全认证: UL, PSE

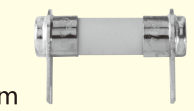

LAC 系列

尺寸: φ14.3x39mm
额定电压: AC600V(40,63A)
AC250V(100~125A)
额定电流: 40,63,100,125A
安全认证: UL, PSE

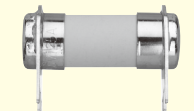

UAC

尺寸: φ20.9x41mm
额定电压: AC250V
额定电流: 200A
安全认证: UL, PSE



FUSE② DC/AC 逆变器

D51 系列
尺寸: φ5.2x20mm
额定电压: DC450V(1~10A)
额定电流: 1~10A
安全认证: UL

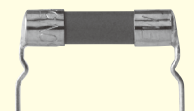

MF66NM 系列
尺寸: φ6.35x31.8mm
额定电压: DC650V(1~8A)
DC450V(10~30A)
额定电流: 1~30A
安全认证: UL



FUSE③ 控制器

KMS 系列
尺寸: 3.2x1.6x0.7mm (SMD 型)
额定电压: DC76V
额定电流: 1.6~15A
安全认证: UL



LM 系列 (黑色/透明色)
尺寸: 10x4x8mm
额定电压: DC48V
额定电流: 0.3~5A
安全认证: UL, TUV



轨道交通应用

售票机



地铁闸机



屏蔽门



主控器

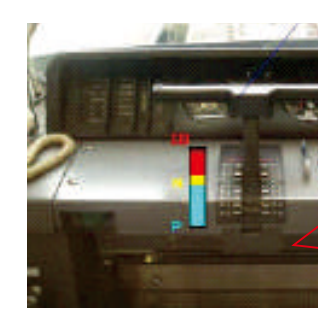

风扇单元



车门

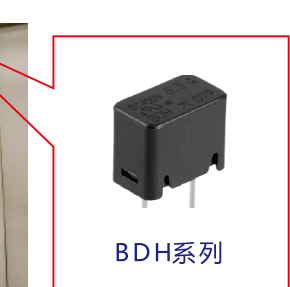

摇动制动器

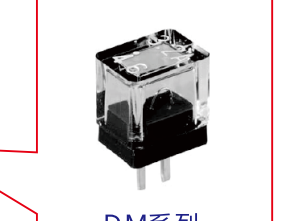

速度计

