

S-1313系列是使用CMOS技术开发的超低消耗电流，低压差的正电压型电压稳压器。

消耗电流仅为0.9 μA (典型值)，且可使用大于或等于0.1 μF 的陶瓷电容器作为输入、输出电容器。

其输出电压精度高达 $\pm 1.0\%$ 。

■ 特点

- 输出电压：在1.0 V ~ 3.5 V的范围内，可以0.05 V为进阶单位来选择
- 输入电压：1.5 V ~ 5.5 V
- 输出电压精度： $\pm 1.0\%$ (1.0 V ~ 1.45 V输出产品： ± 15 mV)
- 输入输出电压差：170 mV (典型值) (2.8 V输出产品, $I_{\text{OUT}} = 100$ mA)
- 消耗电流：工作时：0.9 μA (典型值), 1.35 μA (最大值)
休眠时：0.01 μA (典型值), 0.1 μA (最大值)
- 输出电流：可输出200 mA ($V_{\text{OUT(S)}} \geq 1.4$ V, $V_{\text{IN}} \geq V_{\text{OUT(S)}} + 1.0$ V)^{*1}
- 输入、输出电容器：能够使用大于或等于0.1 μF 的陶瓷电容器
- 内置过载电流保护电路：限制输出晶体管的过载电流
- 内置热敏关闭电路：防止因发热引起的对产品的破坏
- 内置ON / OFF控制电路：能够延长电池的使用寿命
- 可选择下拉恒定电流
- 可选择放电分路功能
- 工作温度范围： $T_a = -40^\circ\text{C} \sim +85^\circ\text{C}$
- 无铅 (Sn 100%)、无卤素

*1. 请注意在输出大电流时的封装容许功耗。

■ 用途

- 携带通信设备、数码相机、数码音响设备的稳压电源
- 以电池供电的设备的稳压电源
- 家电产品的稳压电源

■ 封装

- SOT-23-5
- SC-82AB
- HSNT-4 (1010)
- HSNT-4 (0808)

■ 框图

1. S-1313系列A型

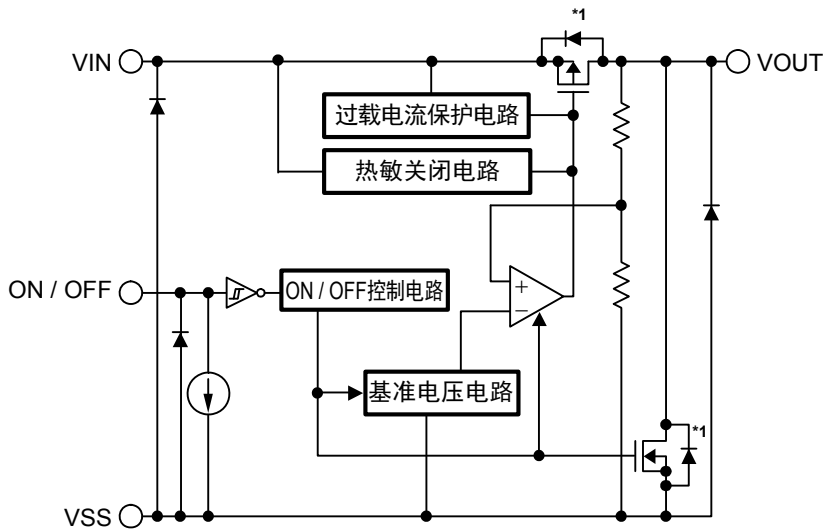

功能	状态
ON / OFF逻辑	动态 "H"
放电分路功能	有
下拉恒定电流	有

*1. 寄生二极管

图1

2. S-1313系列B型

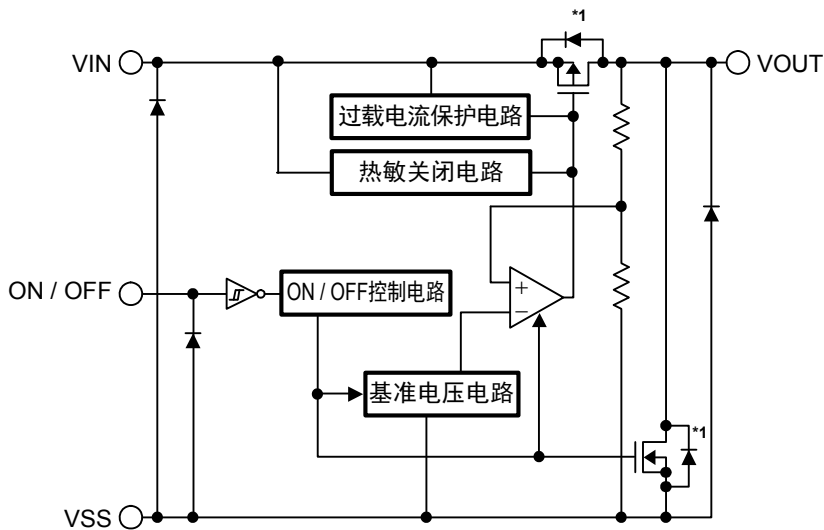

功能	状态
ON / OFF逻辑	动态 "H"
放电分路功能	有
下拉恒定电流	无

*1. 寄生二极管

图2

3. S-1313系列C型

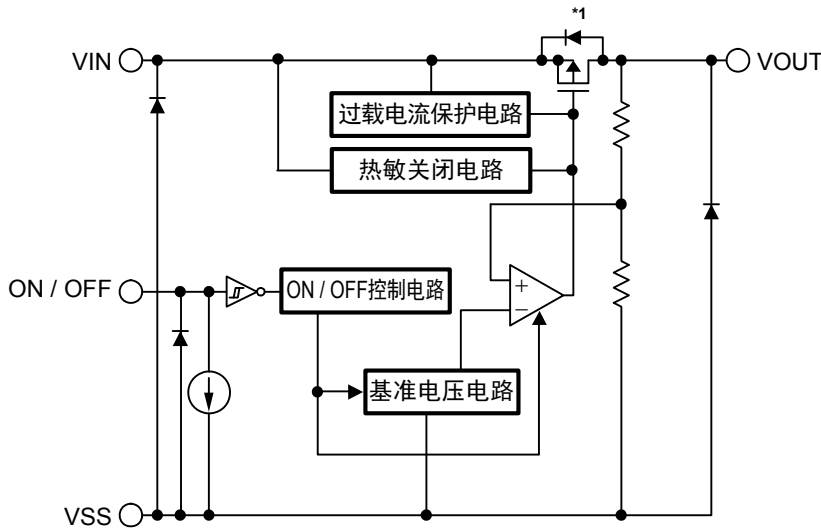

功能	状态
ON / OFF逻辑	动态 "H"
放电分路功能	无
下拉恒定电流	有

*1. 寄生二极管

图3

4. S-1313系列D型

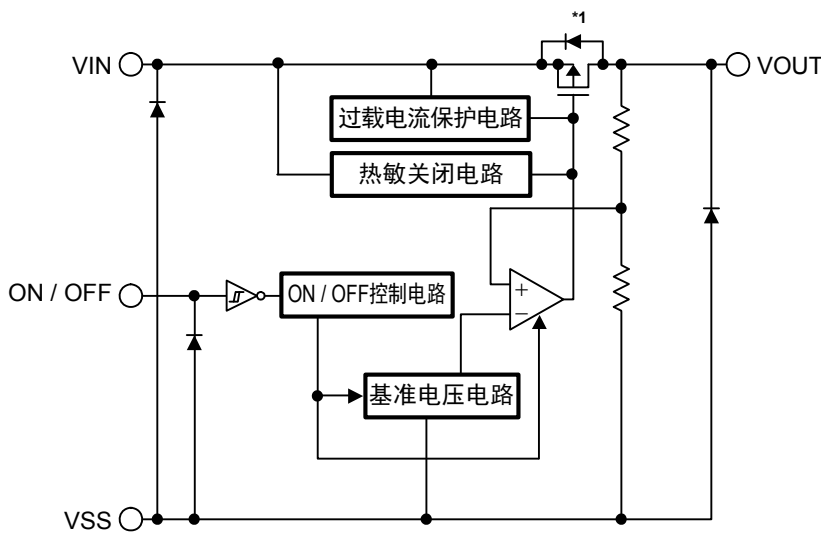

功能	状态
ON / OFF逻辑	动态 "H"
放电分路功能	无
下拉恒定电流	无

*1. 寄生二极管

图4

■ 产品型号的构成

关于S-1313系列，用户可根据用途选择指定产品的类型、输出电压值和封装类型。关于产品名的文字含义请参阅 "1. 产品名"、关于产品类型请参阅 "2. 各产品类型的功能一览"、关于封装图面请参阅 "3. 封装"、关于所有的产品名，请参阅 "4. 产品名目录"。

1. 产品名

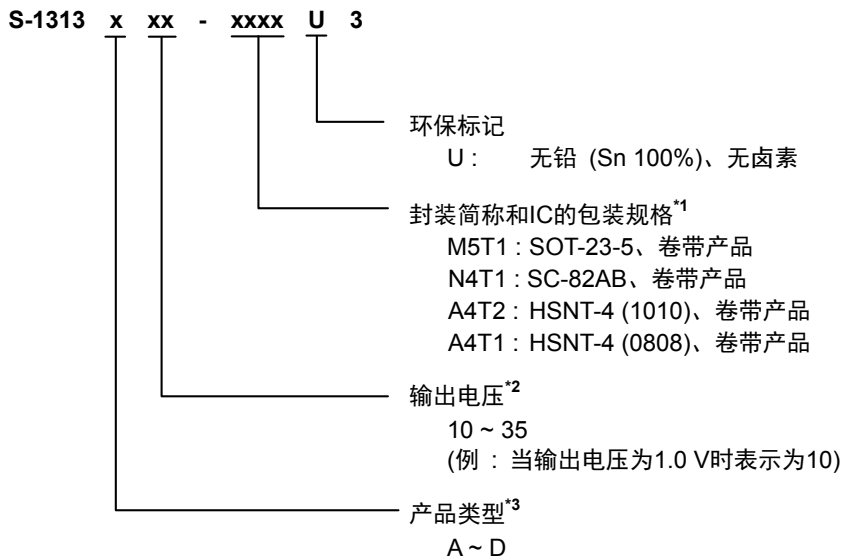

*1. 请参阅卷带图。

*2. 用户需要0.05 V进阶单位的卷带产品时，请向本公司营业部咨询。

*3. 请参阅 "2. 各产品类型的功能一览"。

2. 各产品类型的功能一览

表1

产品类型	ON / OFF逻辑	放电分路功能	下拉恒定电流
A	动态 "H"	有	有
B	动态 "H"	有	无
C	动态 "H"	无	有
D	动态 "H"	无	无

3. 封装

表2 封装图纸号码

封装名	外形尺寸图	卷带图	带卷图	焊盘图
SOT-23-5	MP005-A-P-SD	MP005-A-C-SD	MP005-A-R-SD	-
SC-82AB	NP004-A-P-SD	NP004-A-C-SD NP004-A-C-S1	NP004-A-R-SD	-
HSNT-4 (1010)	PL004-A-P-SD	PL004-A-C-SD	PL004-A-R-SD	PL004-A-L-SD
HSNT-4 (0808)	PK004-A-P-SD	PK004-A-C-SD	PK004-A-R-SD	PK004-A-L-SD

4. 产品名目录

4.1 S-1313系列A型

ON / OFF逻辑： 动态 "H"

放电分路功能： 有

下拉恒定电流： 有

表3

输出电压	SOT-23-5	SC-82AB	HSNT-4 (1010)	HSNT-4 (0808)
1.0 V ± 15 mV	S-1313A10-M5T1U3	S-1313A10-N4T1U3	S-1313A10-A4T2U3	S-1313A10-A4T1U3
1.1 V ± 15 mV	S-1313A11-M5T1U3	S-1313A11-N4T1U3	S-1313A11-A4T2U3	S-1313A11-A4T1U3
1.2 V ± 15 mV	S-1313A12-M5T1U3	S-1313A12-N4T1U3	S-1313A12-A4T2U3	S-1313A12-A4T1U3
1.3 V ± 15 mV	S-1313A13-M5T1U3	S-1313A13-N4T1U3	S-1313A13-A4T2U3	S-1313A13-A4T1U3
1.4 V ± 15 mV	S-1313A14-M5T1U3	S-1313A14-N4T1U3	S-1313A14-A4T2U3	S-1313A14-A4T1U3
1.5 V ± 1.0%	S-1313A15-M5T1U3	S-1313A15-N4T1U3	S-1313A15-A4T2U3	S-1313A15-A4T1U3
1.6 V ± 1.0%	S-1313A16-M5T1U3	S-1313A16-N4T1U3	S-1313A16-A4T2U3	S-1313A16-A4T1U3
1.7 V ± 1.0%	S-1313A17-M5T1U3	S-1313A17-N4T1U3	S-1313A17-A4T2U3	S-1313A17-A4T1U3
1.8 V ± 1.0%	S-1313A18-M5T1U3	S-1313A18-N4T1U3	S-1313A18-A4T2U3	S-1313A18-A4T1U3
1.85 V ± 1.0%	S-1313A1J-M5T1U3	S-1313A1J-N4T1U3	S-1313A1J-A4T2U3	S-1313A1J-A4T1U3
1.9 V ± 1.0%	S-1313A19-M5T1U3	S-1313A19-N4T1U3	S-1313A19-A4T2U3	S-1313A19-A4T1U3
2.0 V ± 1.0%	S-1313A20-M5T1U3	S-1313A20-N4T1U3	S-1313A20-A4T2U3	S-1313A20-A4T1U3
2.1 V ± 1.0%	S-1313A21-M5T1U3	S-1313A21-N4T1U3	S-1313A21-A4T2U3	S-1313A21-A4T1U3
2.2 V ± 1.0%	S-1313A22-M5T1U3	S-1313A22-N4T1U3	S-1313A22-A4T2U3	S-1313A22-A4T1U3
2.3 V ± 1.0%	S-1313A23-M5T1U3	S-1313A23-N4T1U3	S-1313A23-A4T2U3	S-1313A23-A4T1U3
2.4 V ± 1.0%	S-1313A24-M5T1U3	S-1313A24-N4T1U3	S-1313A24-A4T2U3	S-1313A24-A4T1U3
2.5 V ± 1.0%	S-1313A25-M5T1U3	S-1313A25-N4T1U3	S-1313A25-A4T2U3	S-1313A25-A4T1U3
2.6 V ± 1.0%	S-1313A26-M5T1U3	S-1313A26-N4T1U3	S-1313A26-A4T2U3	S-1313A26-A4T1U3
2.7 V ± 1.0%	S-1313A27-M5T1U3	S-1313A27-N4T1U3	S-1313A27-A4T2U3	S-1313A27-A4T1U3
2.8 V ± 1.0%	S-1313A28-M5T1U3	S-1313A28-N4T1U3	S-1313A28-A4T2U3	S-1313A28-A4T1U3
2.85 V ± 1.0%	S-1313A2J-M5T1U3	S-1313A2J-N4T1U3	S-1313A2J-A4T2U3	S-1313A2J-A4T1U3
2.9 V ± 1.0%	S-1313A29-M5T1U3	S-1313A29-N4T1U3	S-1313A29-A4T2U3	S-1313A29-A4T1U3
3.0 V ± 1.0%	S-1313A30-M5T1U3	S-1313A30-N4T1U3	S-1313A30-A4T2U3	S-1313A30-A4T1U3
3.1 V ± 1.0%	S-1313A31-M5T1U3	S-1313A31-N4T1U3	S-1313A31-A4T2U3	S-1313A31-A4T1U3
3.2 V ± 1.0%	S-1313A32-M5T1U3	S-1313A32-N4T1U3	S-1313A32-A4T2U3	S-1313A32-A4T1U3
3.3 V ± 1.0%	S-1313A33-M5T1U3	S-1313A33-N4T1U3	S-1313A33-A4T2U3	S-1313A33-A4T1U3
3.4 V ± 1.0%	S-1313A34-M5T1U3	S-1313A34-N4T1U3	S-1313A34-A4T2U3	S-1313A34-A4T1U3
3.5 V ± 1.0%	S-1313A35-M5T1U3	S-1313A35-N4T1U3	S-1313A35-A4T2U3	S-1313A35-A4T1U3

备注 用户需要上述以外的产品时，请向本公司营业部咨询。

4.2 S-1313系列B型

ON / OFF逻辑 : 动态 "H"

放电分路功能 : 有

下拉恒定电流 : 无

表4

输出电压	SOT-23-5	SC-82AB	HSNT-4 (1010)	HSNT-4 (0808)
1.0 V ± 15 mV	S-1313B10-M5T1U3	S-1313B10-N4T1U3	S-1313B10-A4T2U3	S-1313B10-A4T1U3
1.1 V ± 15 mV	S-1313B11-M5T1U3	S-1313B11-N4T1U3	S-1313B11-A4T2U3	S-1313B11-A4T1U3
1.2 V ± 15 mV	S-1313B12-M5T1U3	S-1313B12-N4T1U3	S-1313B12-A4T2U3	S-1313B12-A4T1U3
1.3 V ± 15 mV	S-1313B13-M5T1U3	S-1313B13-N4T1U3	S-1313B13-A4T2U3	S-1313B13-A4T1U3
1.4 V ± 15 mV	S-1313B14-M5T1U3	S-1313B14-N4T1U3	S-1313B14-A4T2U3	S-1313B14-A4T1U3
1.5 V ± 1.0%	S-1313B15-M5T1U3	S-1313B15-N4T1U3	S-1313B15-A4T2U3	S-1313B15-A4T1U3
1.6 V ± 1.0%	S-1313B16-M5T1U3	S-1313B16-N4T1U3	S-1313B16-A4T2U3	S-1313B16-A4T1U3
1.7 V ± 1.0%	S-1313B17-M5T1U3	S-1313B17-N4T1U3	S-1313B17-A4T2U3	S-1313B17-A4T1U3
1.8 V ± 1.0%	S-1313B18-M5T1U3	S-1313B18-N4T1U3	S-1313B18-A4T2U3	S-1313B18-A4T1U3
1.85 V ± 1.0%	S-1313B1J-M5T1U3	S-1313B1J-N4T1U3	S-1313B1J-A4T2U3	S-1313B1J-A4T1U3
1.9 V ± 1.0%	S-1313B19-M5T1U3	S-1313B19-N4T1U3	S-1313B19-A4T2U3	S-1313B19-A4T1U3
2.0 V ± 1.0%	S-1313B20-M5T1U3	S-1313B20-N4T1U3	S-1313B20-A4T2U3	S-1313B20-A4T1U3
2.1 V ± 1.0%	S-1313B21-M5T1U3	S-1313B21-N4T1U3	S-1313B21-A4T2U3	S-1313B21-A4T1U3
2.2 V ± 1.0%	S-1313B22-M5T1U3	S-1313B22-N4T1U3	S-1313B22-A4T2U3	S-1313B22-A4T1U3
2.3 V ± 1.0%	S-1313B23-M5T1U3	S-1313B23-N4T1U3	S-1313B23-A4T2U3	S-1313B23-A4T1U3
2.4 V ± 1.0%	S-1313B24-M5T1U3	S-1313B24-N4T1U3	S-1313B24-A4T2U3	S-1313B24-A4T1U3
2.5 V ± 1.0%	S-1313B25-M5T1U3	S-1313B25-N4T1U3	S-1313B25-A4T2U3	S-1313B25-A4T1U3
2.6 V ± 1.0%	S-1313B26-M5T1U3	S-1313B26-N4T1U3	S-1313B26-A4T2U3	S-1313B26-A4T1U3
2.7 V ± 1.0%	S-1313B27-M5T1U3	S-1313B27-N4T1U3	S-1313B27-A4T2U3	S-1313B27-A4T1U3
2.8 V ± 1.0%	S-1313B28-M5T1U3	S-1313B28-N4T1U3	S-1313B28-A4T2U3	S-1313B28-A4T1U3
2.85 V ± 1.0%	S-1313B2J-M5T1U3	S-1313B2J-N4T1U3	S-1313B2J-A4T2U3	S-1313B2J-A4T1U3
2.9 V ± 1.0%	S-1313B29-M5T1U3	S-1313B29-N4T1U3	S-1313B29-A4T2U3	S-1313B29-A4T1U3
3.0 V ± 1.0%	S-1313B30-M5T1U3	S-1313B30-N4T1U3	S-1313B30-A4T2U3	S-1313B30-A4T1U3
3.1 V ± 1.0%	S-1313B31-M5T1U3	S-1313B31-N4T1U3	S-1313B31-A4T2U3	S-1313B31-A4T1U3
3.2 V ± 1.0%	S-1313B32-M5T1U3	S-1313B32-N4T1U3	S-1313B32-A4T2U3	S-1313B32-A4T1U3
3.3 V ± 1.0%	S-1313B33-M5T1U3	S-1313B33-N4T1U3	S-1313B33-A4T2U3	S-1313B33-A4T1U3
3.4 V ± 1.0%	S-1313B34-M5T1U3	S-1313B34-N4T1U3	S-1313B34-A4T2U3	S-1313B34-A4T1U3
3.5 V ± 1.0%	S-1313B35-M5T1U3	S-1313B35-N4T1U3	S-1313B35-A4T2U3	S-1313B35-A4T1U3

备注 用户需要上述以外的产品时, 请向本公司营业部咨询。

4.3 S-1313系列C型

ON / OFF逻辑： 动态 "H"

放电分路功能： 无

下拉恒定电流： 有

表5

输出电压	SOT-23-5	SC-82AB	HSNT-4 (1010)	HSNT-4 (0808)
1.0 V ± 15 mV	S-1313C10-M5T1U3	S-1313C10-N4T1U3	S-1313C10-A4T2U3	S-1313C10-A4T1U3
1.1 V ± 15 mV	S-1313C11-M5T1U3	S-1313C11-N4T1U3	S-1313C11-A4T2U3	S-1313C11-A4T1U3
1.2 V ± 15 mV	S-1313C12-M5T1U3	S-1313C12-N4T1U3	S-1313C12-A4T2U3	S-1313C12-A4T1U3
1.3 V ± 15 mV	S-1313C13-M5T1U3	S-1313C13-N4T1U3	S-1313C13-A4T2U3	S-1313C13-A4T1U3
1.4 V ± 15 mV	S-1313C14-M5T1U3	S-1313C14-N4T1U3	S-1313C14-A4T2U3	S-1313C14-A4T1U3
1.5 V ± 1.0%	S-1313C15-M5T1U3	S-1313C15-N4T1U3	S-1313C15-A4T2U3	S-1313C15-A4T1U3
1.6 V ± 1.0%	S-1313C16-M5T1U3	S-1313C16-N4T1U3	S-1313C16-A4T2U3	S-1313C16-A4T1U3
1.7 V ± 1.0%	S-1313C17-M5T1U3	S-1313C17-N4T1U3	S-1313C17-A4T2U3	S-1313C17-A4T1U3
1.8 V ± 1.0%	S-1313C18-M5T1U3	S-1313C18-N4T1U3	S-1313C18-A4T2U3	S-1313C18-A4T1U3
1.85 V ± 1.0%	S-1313C1J-M5T1U3	S-1313C1J-N4T1U3	S-1313C1J-A4T2U3	S-1313C1J-A4T1U3
1.9 V ± 1.0%	S-1313C19-M5T1U3	S-1313C19-N4T1U3	S-1313C19-A4T2U3	S-1313C19-A4T1U3
2.0 V ± 1.0%	S-1313C20-M5T1U3	S-1313C20-N4T1U3	S-1313C20-A4T2U3	S-1313C20-A4T1U3
2.1 V ± 1.0%	S-1313C21-M5T1U3	S-1313C21-N4T1U3	S-1313C21-A4T2U3	S-1313C21-A4T1U3
2.2 V ± 1.0%	S-1313C22-M5T1U3	S-1313C22-N4T1U3	S-1313C22-A4T2U3	S-1313C22-A4T1U3
2.3 V ± 1.0%	S-1313C23-M5T1U3	S-1313C23-N4T1U3	S-1313C23-A4T2U3	S-1313C23-A4T1U3
2.4 V ± 1.0%	S-1313C24-M5T1U3	S-1313C24-N4T1U3	S-1313C24-A4T2U3	S-1313C24-A4T1U3
2.5 V ± 1.0%	S-1313C25-M5T1U3	S-1313C25-N4T1U3	S-1313C25-A4T2U3	S-1313C25-A4T1U3
2.6 V ± 1.0%	S-1313C26-M5T1U3	S-1313C26-N4T1U3	S-1313C26-A4T2U3	S-1313C26-A4T1U3
2.7 V ± 1.0%	S-1313C27-M5T1U3	S-1313C27-N4T1U3	S-1313C27-A4T2U3	S-1313C27-A4T1U3
2.8 V ± 1.0%	S-1313C28-M5T1U3	S-1313C28-N4T1U3	S-1313C28-A4T2U3	S-1313C28-A4T1U3
2.85 V ± 1.0%	S-1313C2J-M5T1U3	S-1313C2J-N4T1U3	S-1313C2J-A4T2U3	S-1313C2J-A4T1U3
2.9 V ± 1.0%	S-1313C29-M5T1U3	S-1313C29-N4T1U3	S-1313C29-A4T2U3	S-1313C29-A4T1U3
3.0 V ± 1.0%	S-1313C30-M5T1U3	S-1313C30-N4T1U3	S-1313C30-A4T2U3	S-1313C30-A4T1U3
3.1 V ± 1.0%	S-1313C31-M5T1U3	S-1313C31-N4T1U3	S-1313C31-A4T2U3	S-1313C31-A4T1U3
3.2 V ± 1.0%	S-1313C32-M5T1U3	S-1313C32-N4T1U3	S-1313C32-A4T2U3	S-1313C32-A4T1U3
3.3 V ± 1.0%	S-1313C33-M5T1U3	S-1313C33-N4T1U3	S-1313C33-A4T2U3	S-1313C33-A4T1U3
3.4 V ± 1.0%	S-1313C34-M5T1U3	S-1313C34-N4T1U3	S-1313C34-A4T2U3	S-1313C34-A4T1U3
3.5 V ± 1.0%	S-1313C35-M5T1U3	S-1313C35-N4T1U3	S-1313C35-A4T2U3	S-1313C35-A4T1U3

备注 用户需要上述以外的产品时, 请向本公司营业部咨询。

4.4 S-1313系列D型

ON / OFF逻辑： 动态 "H"

放电分路功能： 无

下拉恒定电流： 无

表6

输出电压	SOT-23-5	SC-82AB	HSNT-4 (1010)	HSNT-4 (0808)
1.0 V ± 15 mV	S-1313D10-M5T1U3	S-1313D10-N4T1U3	S-1313D10-A4T2U3	S-1313D10-A4T1U3
1.1 V ± 15 mV	S-1313D11-M5T1U3	S-1313D11-N4T1U3	S-1313D11-A4T2U3	S-1313D11-A4T1U3
1.2 V ± 15 mV	S-1313D12-M5T1U3	S-1313D12-N4T1U3	S-1313D12-A4T2U3	S-1313D12-A4T1U3
1.3 V ± 15 mV	S-1313D13-M5T1U3	S-1313D13-N4T1U3	S-1313D13-A4T2U3	S-1313D13-A4T1U3
1.4 V ± 15 mV	S-1313D14-M5T1U3	S-1313D14-N4T1U3	S-1313D14-A4T2U3	S-1313D14-A4T1U3
1.5 V ± 1.0%	S-1313D15-M5T1U3	S-1313D15-N4T1U3	S-1313D15-A4T2U3	S-1313D15-A4T1U3
1.6 V ± 1.0%	S-1313D16-M5T1U3	S-1313D16-N4T1U3	S-1313D16-A4T2U3	S-1313D16-A4T1U3
1.7 V ± 1.0%	S-1313D17-M5T1U3	S-1313D17-N4T1U3	S-1313D17-A4T2U3	S-1313D17-A4T1U3
1.8 V ± 1.0%	S-1313D18-M5T1U3	S-1313D18-N4T1U3	S-1313D18-A4T2U3	S-1313D18-A4T1U3
1.85 V ± 1.0%	S-1313D1J-M5T1U3	S-1313D1J-N4T1U3	S-1313D1J-A4T2U3	S-1313D1J-A4T1U3
1.9 V ± 1.0%	S-1313D19-M5T1U3	S-1313D19-N4T1U3	S-1313D19-A4T2U3	S-1313D19-A4T1U3
2.0 V ± 1.0%	S-1313D20-M5T1U3	S-1313D20-N4T1U3	S-1313D20-A4T2U3	S-1313D20-A4T1U3
2.1 V ± 1.0%	S-1313D21-M5T1U3	S-1313D21-N4T1U3	S-1313D21-A4T2U3	S-1313D21-A4T1U3
2.2 V ± 1.0%	S-1313D22-M5T1U3	S-1313D22-N4T1U3	S-1313D22-A4T2U3	S-1313D22-A4T1U3
2.3 V ± 1.0%	S-1313D23-M5T1U3	S-1313D23-N4T1U3	S-1313D23-A4T2U3	S-1313D23-A4T1U3
2.4 V ± 1.0%	S-1313D24-M5T1U3	S-1313D24-N4T1U3	S-1313D24-A4T2U3	S-1313D24-A4T1U3
2.5 V ± 1.0%	S-1313D25-M5T1U3	S-1313D25-N4T1U3	S-1313D25-A4T2U3	S-1313D25-A4T1U3
2.6 V ± 1.0%	S-1313D26-M5T1U3	S-1313D26-N4T1U3	S-1313D26-A4T2U3	S-1313D26-A4T1U3
2.7 V ± 1.0%	S-1313D27-M5T1U3	S-1313D27-N4T1U3	S-1313D27-A4T2U3	S-1313D27-A4T1U3
2.8 V ± 1.0%	S-1313D28-M5T1U3	S-1313D28-N4T1U3	S-1313D28-A4T2U3	S-1313D28-A4T1U3
2.85 V ± 1.0%	S-1313D2J-M5T1U3	S-1313D2J-N4T1U3	S-1313D2J-A4T2U3	S-1313D2J-A4T1U3
2.9 V ± 1.0%	S-1313D29-M5T1U3	S-1313D29-N4T1U3	S-1313D29-A4T2U3	S-1313D29-A4T1U3
3.0 V ± 1.0%	S-1313D30-M5T1U3	S-1313D30-N4T1U3	S-1313D30-A4T2U3	S-1313D30-A4T1U3
3.1 V ± 1.0%	S-1313D31-M5T1U3	S-1313D31-N4T1U3	S-1313D31-A4T2U3	S-1313D31-A4T1U3
3.2 V ± 1.0%	S-1313D32-M5T1U3	S-1313D32-N4T1U3	S-1313D32-A4T2U3	S-1313D32-A4T1U3
3.3 V ± 1.0%	S-1313D33-M5T1U3	S-1313D33-N4T1U3	S-1313D33-A4T2U3	S-1313D33-A4T1U3
3.4 V ± 1.0%	S-1313D34-M5T1U3	S-1313D34-N4T1U3	S-1313D34-A4T2U3	S-1313D34-A4T1U3
3.5 V ± 1.0%	S-1313D35-M5T1U3	S-1313D35-N4T1U3	S-1313D35-A4T2U3	S-1313D35-A4T1U3

备注 用户需要上述以外的产品时，请向本公司营业部咨询。

■ 引脚排列图

1. SOT-23-5



图5

表7

引脚号	符号	描述
1	VIN	电压输入端子
2	VSS	接地 (GND) 端子
3	ON / OFF	ON / OFF端子
4	NC ^{*1}	无连接
5	VOUT	电压输出端子

*1. NC表示处于电气开路状态。

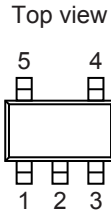
所以，可以与VIN端子或VSS端子连接。

2. SC-82AB



图6

表8

引脚号	符号	描述
1	ON / OFF	ON / OFF端子
2	VSS	接地 (GND) 端子
3	VOUT	电压输出端子
4	VIN	电压输入端子

3. HSNT-4 (1010)

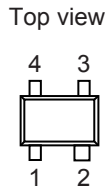
Top view



Bottom view

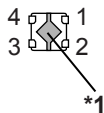

- *1. 请将阴影部分的底面散热板与基板连接，并将电位设置为开路状态或GND。但请不要作为电极使用。

图7

表9

引脚号	符号	描述
1	VOUT	电压输出端子
2	VSS	接地 (GND) 端子
3	ON / OFF	ON / OFF端子
4	VIN	电压输入端子

4. HSNT-4 (0808)

Top view



Bottom view

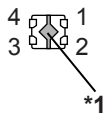

- *1. 请将阴影部分的底面散热板与基板连接，并将电位设置为开路状态或GND。但请不要作为电极使用。

图8

表10

引脚号	符号	描述
1	VOUT	电压输出端子
2	VSS	接地 (GND) 端子
3	ON / OFF	ON / OFF端子
4	VIN	电压输入端子

■ 绝对最大额定值

表11

(除特殊注明以外 : $T_a = +25^{\circ}\text{C}$)

项目		符号	绝对最大额定值	单位
输入电压		V_{IN}	$V_{\text{SS}} - 0.3 \sim V_{\text{SS}} + 6.0$	V
		$V_{\text{ON/OFF}}$	$V_{\text{SS}} - 0.3 \sim V_{\text{SS}} + 6.0$	V
输出电压		V_{OUT}	$V_{\text{SS}} - 0.3 \sim V_{\text{IN}} + 0.3$	V
输出电流		I_{OUT}	240	mA
容许功耗	SOT-23-5	P_{D}	600 ^{*1}	mW
	SC-82AB		400 ^{*1}	mW
	HSNT-4 (1010)		340 ^{*1}	mW
	HSNT-4 (0808)		335 ^{*1}	mW
工作环境温度		T_{opr}	$-40 \sim +85$	$^{\circ}\text{C}$
保存温度		T_{stg}	$-40 \sim +125$	$^{\circ}\text{C}$

*1. 基板安装时

[安装基板]

- (1) 基板尺寸 : 114.3 mm × 76.2 mm × t1.6 mm
- (2) 名称 : JEDEC STANDARD51-7

注意 绝对最大额定值是指无论在任何条件下都不能超过的额定值。万一超过此额定值, 有可能造成产品劣化等物理性的损伤。



图9 封装容许功耗 (基板安装时)

HSNT-4 (1010), HSNT-4 (0808) 的容许功耗 (参考)

封装容许功耗因安装条件不同而异。
以下检测条件下的容许功耗仅作参考。

[安装基板]

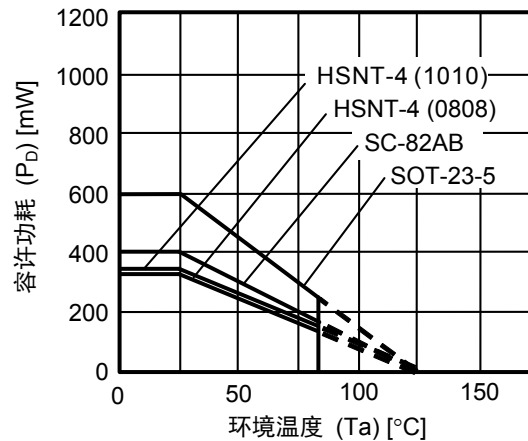
- (1) 基板尺寸 : 40 mm × 40 mm × t0.8 mm
- (2) 基板材料 : 玻璃纤维环氧树脂 (4层)
- (3) 配线占有率 : 50%
- (4) 测定条件 : 基板安装状态 (风速0 m/s)
- (5) 焊盘图 : 请参阅推荐焊盘图
图纸号码 : PL004-A-L-SD (HSNT-4 (1010)), PK004-A-L-SD (HSNT-4 (0808))



图10 封装容许功耗 (基板安装时)

表12

条件	容许功耗 (参考值)	热敏电阻值 ($\theta_j - a$)
HSNT-4 (1010) (基板安装时)	870 mW	115°C/W
HSNT-4 (0808) (基板安装时)	850 mW	117°C/W

■ 电气特性

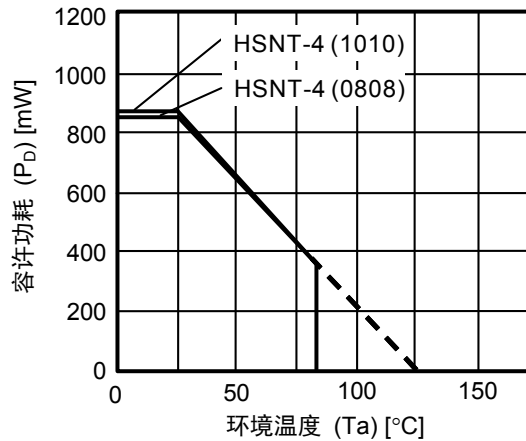
表13

(除特殊注明以外 : Ta = +25°C)

项目	符号	条件	最小值	典型值	最大值	单位	测定电路		
输出电压 ^{*1}	V _{OUT(E)}	V _{IN} = V _{OUT(S)} + 1.0 V, I _{OUT} = 30 mA	1.0 V ≤ V _{OUT(S)} < 1.5 V	V _{OUT(S)} - 0.015	V _{OUT(S)}	V _{OUT(S)} + 0.015	V	1	
			1.5 V ≤ V _{OUT(S)} ≤ 3.5 V	V _{OUT(S)} × 0.99	V _{OUT(S)}	V _{OUT(S)} × 1.01	V	1	
输出电流 ^{*2}	I _{OUT}	V _{IN} ≥ V _{OUT(S)} + 1.0 V	1.0 V ≤ V _{OUT(S)} < 1.1 V	100 ^{*5}	-	-	mA	3	
			1.1 V ≤ V _{OUT(S)} < 1.2 V	125 ^{*5}	-	-	mA	3	
			1.2 V ≤ V _{OUT(S)} < 1.3 V	150 ^{*5}	-	-	mA	3	
			1.3 V ≤ V _{OUT(S)} < 1.4 V	175 ^{*5}	-	-	mA	3	
			1.4 V ≤ V _{OUT(S)} ≤ 3.5 V	200 ^{*5}	-	-	mA	3	
输入输出电压差 ^{*3}	V _{drop}	I _{OUT} = 100 mA	1.0 V ≤ V _{OUT(S)} < 1.1 V	0.50	0.76	1.55	V	1	
			1.1 V ≤ V _{OUT(S)} < 1.2 V	-	0.67	1.39	V	1	
			1.2 V ≤ V _{OUT(S)} < 1.3 V	-	0.58	1.25	V	1	
			1.3 V ≤ V _{OUT(S)} < 1.4 V	-	0.49	1.11	V	1	
			1.4 V ≤ V _{OUT(S)} < 1.5 V	-	0.43	0.99	V	1	
			1.5 V ≤ V _{OUT(S)} < 1.7 V	-	0.37	0.85	V	1	
			1.7 V ≤ V _{OUT(S)} < 1.8 V	-	0.31	0.68	V	1	
			1.8 V ≤ V _{OUT(S)} < 2.0 V	-	0.27	0.58	V	1	
			2.0 V ≤ V _{OUT(S)} < 2.5 V	-	0.23	0.49	V	1	
			2.5 V ≤ V _{OUT(S)} < 2.8 V	-	0.18	0.38	V	1	
2.8 V ≤ V _{OUT(S)} < 3.0 V	-	0.17	0.33	V	1				
3.0 V ≤ V _{OUT(S)} ≤ 3.5 V	-	0.16	0.32	V	1				
输入稳定度	$\frac{\Delta V_{OUT1}}{\Delta V_{IN} \cdot V_{OUT}}$	V _{OUT(S)} + 0.5 V ≤ V _{IN} ≤ 5.5 V, I _{OUT} = 1 μA	1.0 V ≤ V _{OUT(S)} ≤ 3.5 V	-	0.05	0.2	%/V	1	
			1.0 V ≤ V _{OUT(S)} < 1.1 V	-	0.07	2.0	%/V	1	
	$\frac{\Delta V_{OUT1}}{\Delta V_{IN} \cdot V_{OUT}}$	V _{OUT(S)} + 0.5 V ≤ V _{IN} ≤ 5.5 V, I _{OUT} = 30 mA	1.1 V ≤ V _{OUT(S)} < 1.2 V	-	0.06	1.0	%/V	1	
			1.2 V ≤ V _{OUT(S)} ≤ 3.5 V	-	0.05	0.2	%/V	1	
负载稳定度	ΔV _{OUT2}	V _{IN} = V _{OUT(S)} + 1.0 V, 1 μA ≤ I _{OUT} ≤ 100 mA	1.0 V ≤ V _{OUT(S)} ≤ 3.5 V	-	20	40	mV	1	
			V _{IN} = V _{OUT(S)} + 1.0 V, 100 μA ≤ I _{OUT} ≤ 200 mA	1.0 V ≤ V _{OUT(S)} < 1.1 V	-	40	640	mV	1
				1.1 V ≤ V _{OUT(S)} < 1.2 V	-	40	400	mV	1
				1.2 V ≤ V _{OUT(S)} < 1.3 V	-	40	160	mV	1
				1.3 V ≤ V _{OUT(S)} < 1.4 V	-	40	80	mV	1
				1.4 V ≤ V _{OUT(S)} ≤ 3.5 V	-	40	80	mV	1
输出电压温度系数 ^{*4}	$\frac{\Delta V_{OUT}}{\Delta T_a \cdot V_{OUT}}$	V _{IN} = V _{OUT(S)} + 1.0 V, I _{OUT} = 30 mA, -40°C ≤ Ta ≤ +85°C	-	±130	-	ppm/°C	1		
工作时消耗电流	I _{SS1}	V _{IN} = V _{OUT(S)} + 1.0 V, ON / OFF端子为ON、无负载	-	0.9	1.35	μA	2		
休眠时消耗电流	I _{SS2}	V _{IN} = V _{OUT(S)} + 1.0 V, ON / OFF端子为OFF、无负载	-	0.01	0.1	μA	2		
输入电压	V _{IN}	-	1.5	-	5.5	V	-		
ON / OFF端子输入电压 "H"	V _{SH}	V _{IN} = V _{OUT(S)} + 1.0 V, R _L = 1.0 kΩ、通过V _{OUT} 输出电位来判断	1.0	-	-	V	4		
ON / OFF端子输入电压 "L"	V _{SL}	V _{IN} = V _{OUT(S)} + 1.0 V, R _L = 1.0 kΩ、通过V _{OUT} 输出电位来判断	-	-	0.25	V	4		
ON / OFF端子输入电流 "H"	I _{SH}	V _{IN} = 5.5 V, V _{ON / OFF} = 5.5 V	B / D型 (无下拉恒定电流)	-0.1	-	0.1	μA	4	
			A / C型 (备有下拉恒定电流)	0.05	0.1	0.2	μA	4	
ON / OFF端子输入电流 "L"	I _{SL}	V _{IN} = 5.5 V, V _{ON / OFF} = 0 V	-0.1	-	0.1	μA	4		
短路电流	I _{short}	V _{IN} = V _{OUT(S)} + 1.0 V, ON / OFF端子为ON, V _{OUT} = 0 V	-	50	-	mA	3		
热敏关闭检测温度	T _{SD}	结点温度	-	150	-	°C	-		
热敏关闭解除温度	T _{SR}	结点温度	-	120	-	°C	-		
"L"输出N沟道通态电阻	R _{LOW}	V _{OUT} = 0.1 V, V _{IN} = 5.5 V	A / B型 (备有放电分路功能)	-	35	-	Ω	3	

- *1. $V_{OUT(S)}$: 设定输出电压值
 $V_{OUT(E)}$: 实际输出电压值
固定 I_{OUT} (= 30 mA), 并输入 $V_{OUT(S)} + 1.0$ V的电压时的输出电压值
- *2. 缓慢增加输出电流, 输出电压达到 $V_{OUT(E)}$ 的95%时的输出电流值
- *3. $V_{drop} = V_{IN1} - (V_{OUT3} \times 0.98)$
 V_{OUT3} : $V_{IN} = V_{OUT(S)} + 1.0$ V, $I_{OUT} = 100$ mA时的输出电压值
 V_{IN1} : 缓慢降低输入电压, 当输出电压降到 V_{OUT3} 的98%时的输入电压
- *4. 输出电压的温度变化 [mV/°C], 按下式算出。
$$\frac{\Delta V_{OUT}}{\Delta T_a} \text{ [mV/°C]}^{*1} = V_{OUT(S)} \text{ [V]}^{*2} \times \frac{\Delta V_{OUT}}{\Delta T_a \cdot V_{OUT}} \text{ [ppm/°C]}^{*3} \div 1000$$
 - *1. 输出电压的温度变化
 - *2. 设定输出电压值
 - *3. 上述输出电压温度系数
- *5. 意指能够得到此值为止的输出电流。
由于封装容许功耗的不同, 也有不能满足此值的情况。请注意在输出大电流时的封装容许功耗。
此规格为设计保证。

■ 测定电路



图11 测定电路1



图12 测定电路2

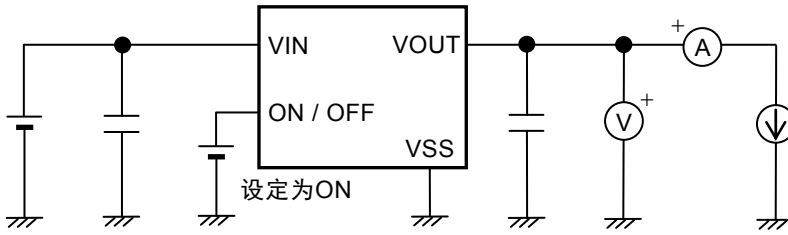

图13 测定电路3

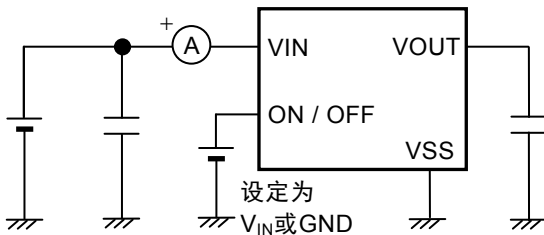

图14 测定电路4

■ 标准电路

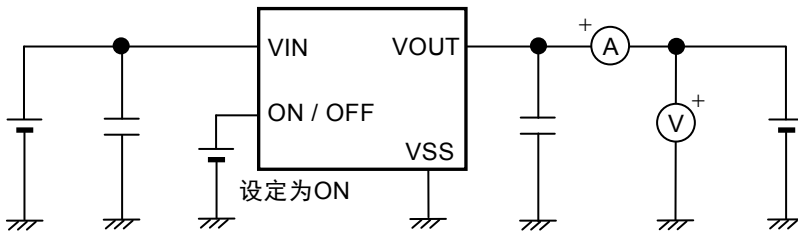

- *1. C_{IN} 为用于稳定输入的电容器。
- *2. C_L 可以使用大于或等于 $0.1 \mu F$ 的陶瓷电容器。

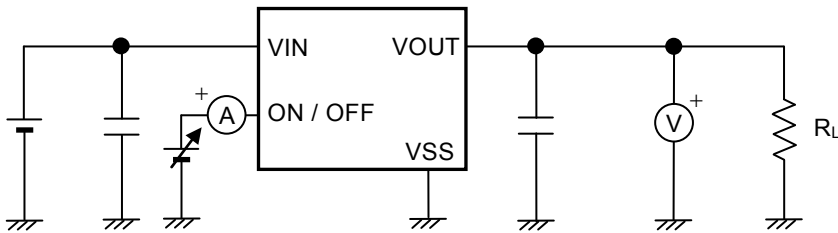
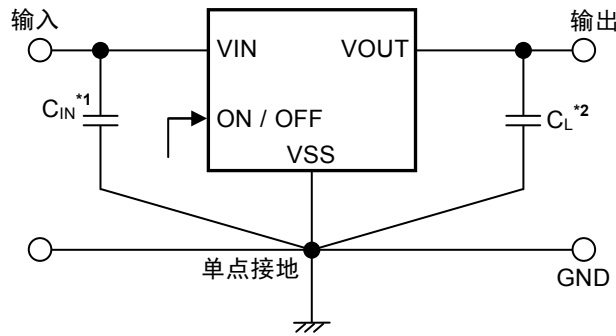
图15

注意 上述连接图以及参数仅供参考，并不作为保证电路工作的依据。请在进行充分的实测基础上，再设定实际的应用电路的参数。

■ 使用条件

输入电容器 (C_{IN}): 大于或等于 $0.1 \mu F$
输出电容器 (C_L): 大于或等于 $0.1 \mu F$

注意 一般而言，线性稳压器有可能因所选择外接元器件的不同发生振荡。请确认使用了上述电容器后，应用电路不发生振荡。

■ 输入、输出电容器 (C_{IN} , C_L) 的选定

S-1313系列在VOUT端子 - VSS端子间需要连接输出电容器以补偿相位。在整个温度范围内，输出电容器使用大于或等于 $0.1 \mu F$ 的陶瓷电容器就可以稳定工作。另外，在使用OS电容器、钽电容器或铝电解电容器时，电容容量也必须大于或等于 $0.1 \mu F$ 。

因输出电容容量的不同，作为过渡响应特性，输出过冲值、下冲值将会发生变化。

另外，输入电容器的必要容量也因应用电路而异。

应用电路的推荐值为 $C_{IN} \geq 0.1 \mu F$, $C_L \geq 0.1 \mu F$ ，在使用时，请对包括温度等特性予以充分的实试验证。

■ 用语的说明

1. 低压差型电压稳压器

指通过内置低通态电阻晶体管来实现低压差的电压稳压器。

2. 输出电压 (V_{OUT})

在输入电压^{*1}、输出电流、温度一定的条件下，输出电压值可保证 $\pm 1.0\%$ 或者 $\pm 15 \text{ mV}^2$ 的精度。

*1. 因产品的不同而有所差异。

*2. $V_{OUT} < 1.5 \text{ V}$ 时： $\pm 15 \text{ mV}$, $V_{OUT} \geq 1.5 \text{ V}$ 时： $\pm 1.0\%$

注意 当这些条件发生变化时，输出电压的值也随之发生变化，有可能导致输出电压的精度超出上述范围。详情请参阅“■ 电气特性”及“■ 各种特性数据 (典型数据)”。

3. 输入稳定度 $\left(\frac{\Delta V_{OUT1}}{\Delta V_{IN} \cdot V_{OUT}} \right)$

表示输出电压对输入电压的依赖性。即，当输出电流一定时，输出电压随输入电压的变化而产生的变化量。

4. 负载稳定度 (ΔV_{OUT2})

表示输出电压对输出电流的依赖性。即，当输入电压一定时，输出电压随输出电流的变化而产生的变化量。

5. 输入输出电压差 (V_{drop})

缓慢降低输入电压 (V_{IN})，当输出电压降低到 $V_{IN} = V_{OUT(S)} + 1.0 \text{ V}$ 时的输出电压值 (V_{OUT3}) 的98%时，输入电压 (V_{IN1}) 与输出电压的差即为输入输出电压差。

$$V_{drop} = V_{IN1} - (V_{OUT3} \times 0.98)$$

6. 输出电压温度系数 $\left(\frac{\Delta V_{OUT}}{\Delta T_a \cdot V_{OUT}}\right)$

输出电压温度系数在 $\pm 130 \text{ ppm}/^\circ\text{C}$ 时的特性，在工作温度范围内表示为如图16所示的阴影范围。

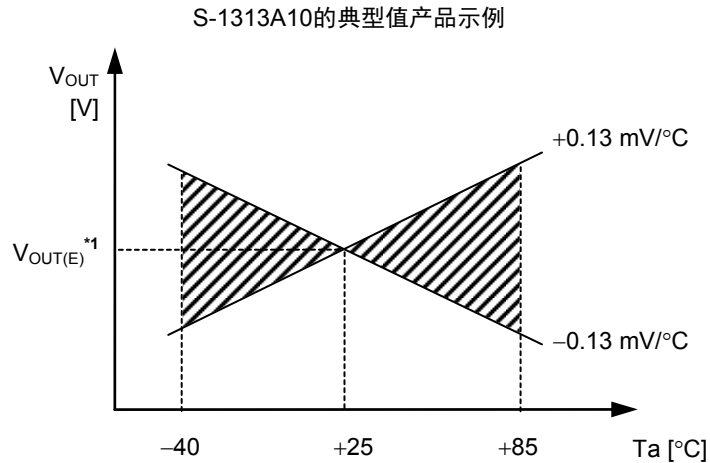

*1. $V_{OUT(E)}$ 为 $T_a = +25^\circ\text{C}$ 时的输出电压测定值。

图16

输出电压的温度变化 [mV/°C]，按下式算出。

$$\frac{\Delta V_{OUT}}{\Delta T_a} [\text{mV}/^\circ\text{C}]^{*1} = V_{OUT(S)} [\text{V}]^{*2} \times \frac{\Delta V_{OUT}}{\Delta T_a \cdot V_{OUT}} [\text{ppm}/^\circ\text{C}]^{*3} \div 1000$$

- *1. 输出电压的温度变化
- *2. 设定输出电压值
- *3. 上述输出电压温度系数

■ 工作说明

1. 基本工作

图17所示为S-1313系列的框图。

输出电压经反馈电阻 (R_s 和 R_f) 分压, 产生反馈电压 (V_{fb}), 并和基准电压 (V_{ref}) 经误差放大器作比较。通过此误差放大器向输出晶体管提供必要的门极电压, 从而使输出电压不受输入电压或温度变化的影响, 能够保持一定。



图17

2. 输出晶体管

S-1313系列的输出晶体管采用了低通态电阻的P沟道MOS FET晶体管。

在晶体管的构造上, 因在VIN端子 - VOUT端子间存在有寄生二极管, 当VOUT的电位高于VIN时, 有可能因反向电流而导致IC被毁坏。因此, 请注意VOUT不要超过VIN + 0.3 V。

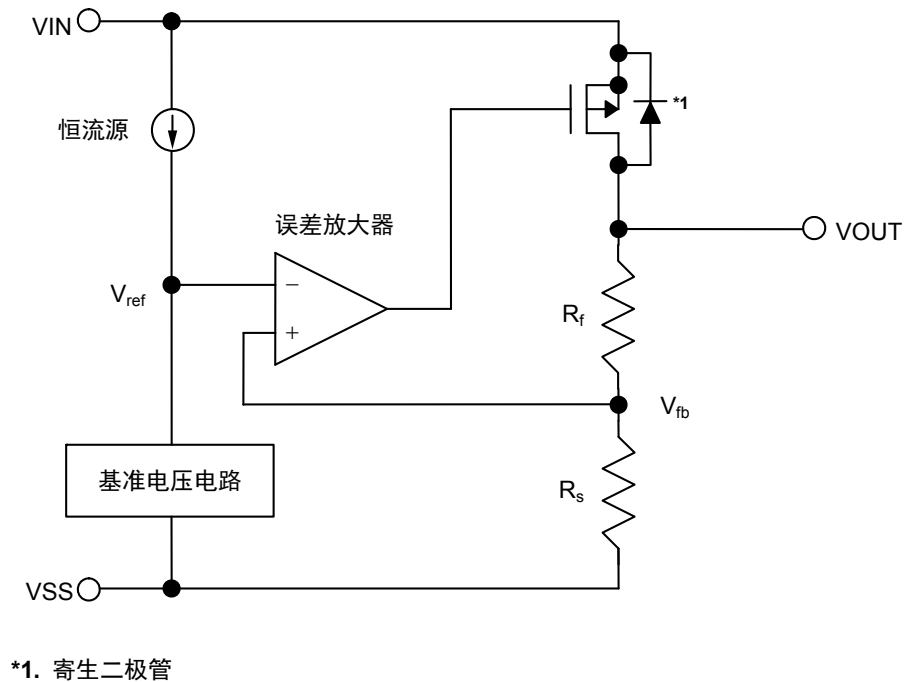
3. ON / OFF端子

启动或者停止进行调压工作。

将ON / OFF端子设定为OFF电位后，会停止内部电路的所有工作，关闭VIN端子 - VOUT端子之间内置的P沟道MOS FET输出晶体管，可以大幅度控制消耗电流。

另外，对ON / OFF端子施加0.25 V ~ $V_{IN} - 0.3$ V的电压后，消耗电流会增大，务请注意。

ON / OFF端子的结构如图18、图19所示。

3.1 S-1313系列A / C型

ON / OFF端子处于浮动状态时，在内部会被下拉至VSS端子，因此VOUT端子会变为V_{SS}电位。

3.2 S-1313系列B / D型

ON / OFF端子在内部不被下拉至VSS端子，因此请不要在浮动状态下使用。另外，不使用ON / OFF端子时，请将其与VIN端子相连接。

表14

产品类型	ON / OFF端子	内部电路	VOUT端子电压	消耗电流
A / B / C / D	"H" : ON	工作	设定值	I_{SS1} ^{*1}
A / B / C / D	"L" : OFF	停止	V _{SS} 电位	I_{SS2}

*1. 将ON / OFF端子连接到VIN端子上进行工作时，S-1313系列A / C型产品的消耗电流中，流入0.1 μ A (典型值) 恒定电流的电流流量会增多，务请注意 (请参阅图18)。



图18 S-1313系列A / C型



图19 S-1313系列B / D型

4. 放电分路功能 (S-1313系列A / B型)

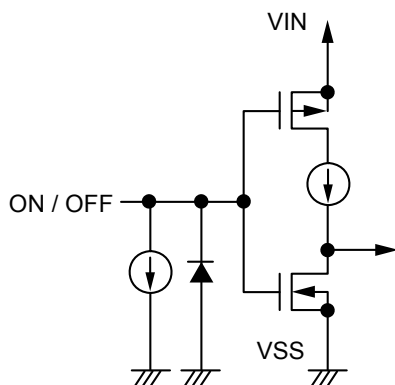
S-1313系列A / B型产品内置了使输出电容放电的放电分路电路。
根据以下步骤使输出电容放电后，VOUT端子就变为V_{SS}电位。

- (1) 将ON / OFF端子设定为OFF电位。
- (2) 关闭输出晶体管。
- (3) 打开放电分路电路。
- (4) 使输出电容器放电。

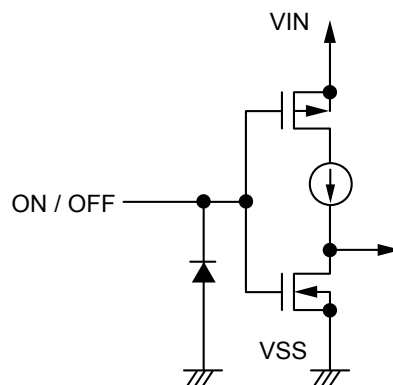
此外，S-1313系列C / D型产品因没有内置放电分路电路，所以在VOUT端子 - VSS端子间内置有数MΩ的分流电阻，使VOUT端子变为V_{SS}电位。S-1313系列A / B型产品凭借放电分路电路，可在最短的时间内使VOUT端子变为V_{SS}电位。

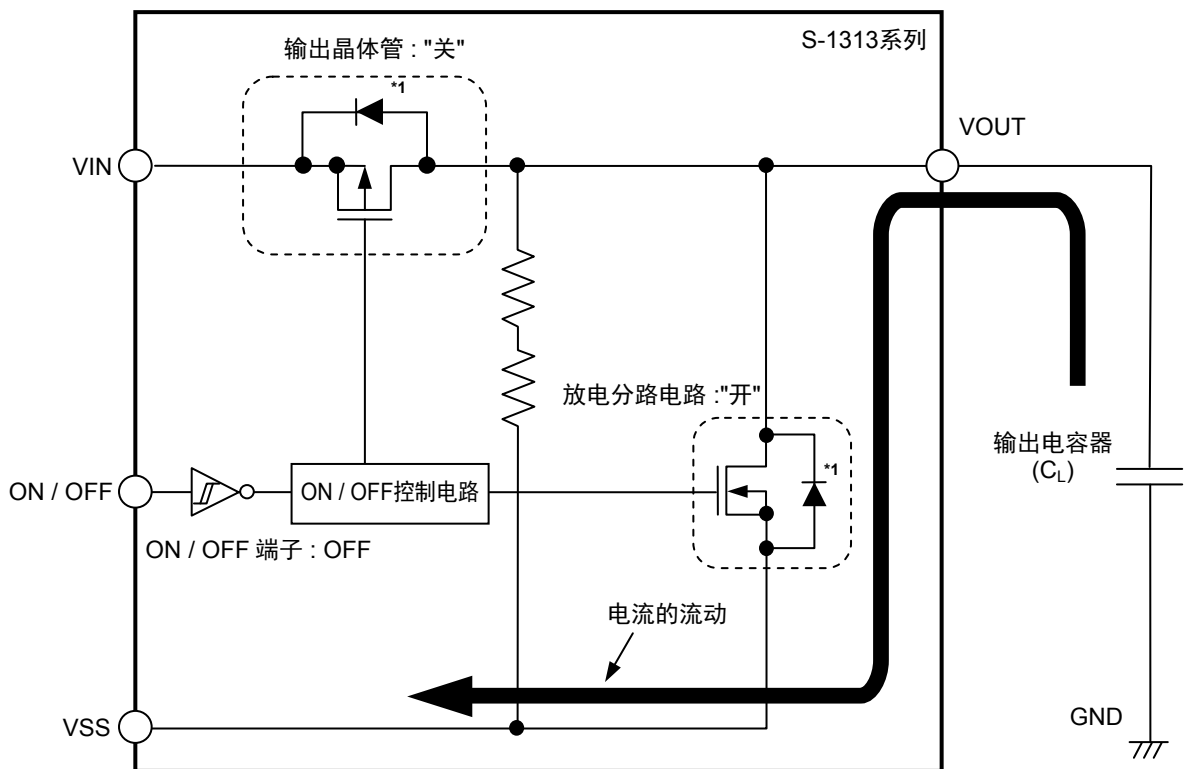

*1. 寄生二极管

图20

5. 下拉恒定电流 (S-1313系列A / C型)

ON / OFF端子处于浮动状态时，在内部会被下拉至VSS端子，因此VOUT端子会变为V_{SS}电位。

将ON / OFF端子连接到VIN端子上进行工作时，S-1313系列A / C型产品的消耗电流中，流入0.1 μA (典型值) 恒定电流中的电流量会增多，务请注意

6. 过载电流保护电路

S-1313系列为了保护输出晶体管免受过大的输出电流及VOUT端子 - VSS端子之间的短路的影响，内置了如 "■ 各种特性数据 (典型数据)" 的 "1. 输出电压 - 输出电流 (负载电流增加时) (Ta = +25°C)" 所示特性的过载电流保护电路。由于输出短路时的电流 (Ishort) 在内部约设定为50 mA (典型值)，因此，只要解除短路状态，输出电压即可恢复为正常值。

注意 过载电流保护电路并非兼备过热保护电路。因此，若长时间持续短路状态，请充分注意输入电压、负载电流的条件，使包括短路条件在内的使用条件下的IC功耗不超过封装的容许功耗。

7. 热敏关闭电路

S-1313系列为了防止因发热而引起的对产品的破坏，内置了热敏关闭电路。当结点温度上升到150°C (典型值) 时，热敏关闭电路开始工作，并停止稳压器的的工作。当结点温度下降到120°C (典型值) 时，热敏关闭电路停止工作，并重新开始进行稳压工作。

由于产品的自身发热而导致热敏关闭电路开始工作时，稳压器将会停止工作，输出电压也随之下降。在稳压器停止工作之后，产品的自身发热会逐渐消失，IC的温度也随之降低。由于温度的降低，热敏关闭电路会停止工作，因此稳压工作重新开始，再一次发生自身发热的现象。如此反复的工作会使输出电压波形变为脉冲状。要阻止这种稳压工作的停止、再重新开始的这种现象，只有通过降低输入电压、输出电流的任意一方或双方，促使内部消耗电力变小来实现，或者通过降低周围环境温度来实现。

表15

热敏关闭电路	VOUT端子电压
开始工作时：150°C (典型值) ^{*1}	VSS电位
解除工作时：120°C (典型值) ^{*1}	设定值

*1. 结点温度

8. 热敏关闭电路停止功能

S-1313系列备有低负载电流时的热敏关闭电路停止功能。

如果负载电流约为小于或等于0.2 mA，则截断流入热敏关闭电路的电流，停止热敏关闭电路的工作。由此可进行超低消耗电流的工作。

如果负载电流达到约为大于或等于0.5 mA，则向热敏关闭电路提供电流，使保护工作成为可能。



图21

■ 注意事项

- 请充分注意VIN端子、VOUT端子以及GND的布线方式,以降低阻抗。另外,请尽可能将输出电容器 (C_L) 连接在VOUT端子 - VSS端子附近,将稳定输入用电容器 (C_{IN}) 连接在VIN端子 - VSS端子附近。
- 一般而言,线性稳压器在低负载电流 (小于或等于10 μA) 状态下使用时,有可能导致输出电压上升,请加以注意。
- 一般而言,线性稳压器在高温状态下使用时,输出驱动器的泄漏电流有可能导致输出电压上升,请加以注意。
- 即使ON / OFF端子处于OFF电位,在高温状态下使用时,输出驱动器的泄漏电流也有可能导致输出电压上升,请加以注意。
- 一般而言,线性稳压器有可能因所选择外接元器件的不同发生振荡。S-1313系列特推荐以下条件,但在实际的使用条件下,请对包括温度特性等进行充分的实测试验后再决定。另外,关于输出电容器的等效串联电阻 (R_{ESR}),请参阅 "■ 参考数据" 的 "6. 等效串联电阻 - 输出电流特性例 (T_a = +25°C)"。

输入电容器 (C_{IN}): 大于或等于0.1 μF
输出电容器 (C_L): 大于或等于0.1 μF

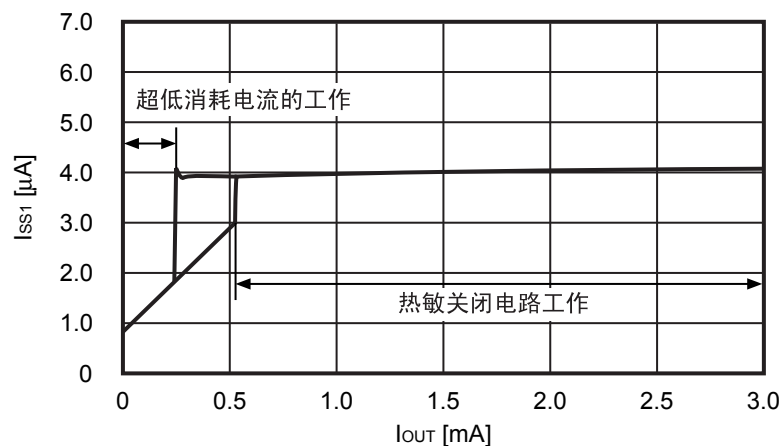
- 在电源的阻抗较高的情况下,IC的输入端所接电容容量偏小或未接电容时,可能会发生振荡,请加以注意。
- 符合以下3个条件时,有可能发生振铃现象。在选择输入电容器时,请在实际使用条件下,对包括温度特性在内等进行充分的实测试验后再决定。

电源的阻抗偏高
负载电流大于或等于100 mA
输入电压与输出电压的差在压差电压附近

- 在IC输出端的电容偏小的情况下,会导致电源变动、负载变动的特性劣化。请在实际使用条件下,对输出电压进行充分的实测试验。
- 若在接通电源时或电源变动时,急剧提升电压,有可能导致在瞬间使输出电压产生过冲。请在实际使用条件下,对接通电源时的输出电压进行充分的实测试验。
- 请注意输入输出电压、负载电流的使用条件,使IC内的功耗不超过封装的容许功耗。
- 本IC虽内置了防静电保护电路,但请不要对IC施加超过保护电路性能的过大静电。
- 有关所需输出电流的设定,请留意 "■ 电气特性" 的表13中输出电流值及栏外的注意事项*5。
- 使用本公司的IC生产产品时,如因其产品中对该IC的使用方法或产品的规格、或因进口国等原因,使包括本IC产品在内的制品发生专利纠纷时,本公司概不承担相应责任。

■ 各种特性数据 (典型数据)

1. 输出电压 – 输出电流 (负载电流增加时) ($T_a = +25^\circ\text{C}$)

1.1 $V_{\text{OUT}} = 1.0 \text{ V}$

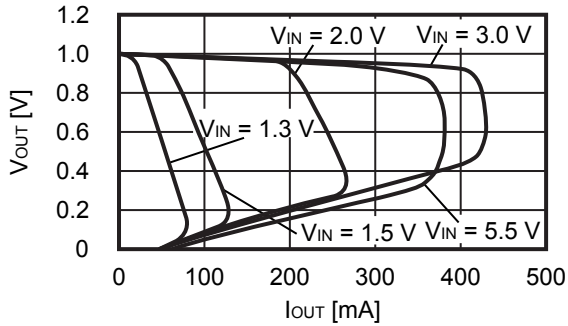

1.2 $V_{\text{OUT}} = 2.5 \text{ V}$

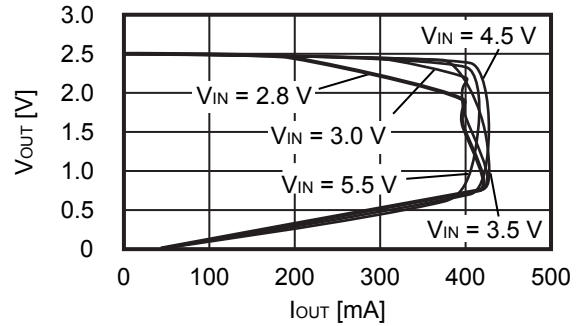

1.3 $V_{\text{OUT}} = 3.5 \text{ V}$

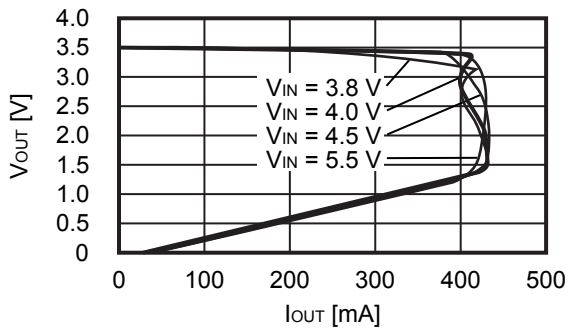

备注 有关所需的输出电流的设定, 请注意如下问题。

1. "■ 电气特性" 的表13中输出电流最小值以及注意事项*5
2. 封装的容许功耗

2. 输出电压 – 输入电压 ($T_a = +25^\circ\text{C}$)

2.1 $V_{\text{OUT}} = 1.0 \text{ V}$

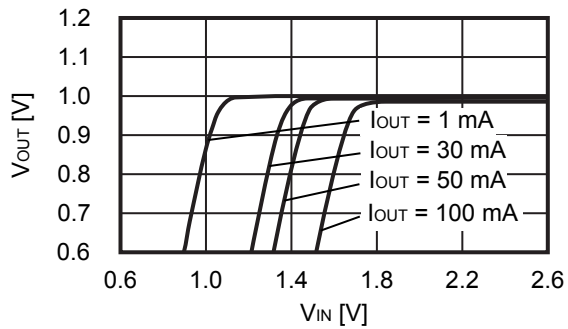

2.2 $V_{\text{OUT}} = 2.5 \text{ V}$

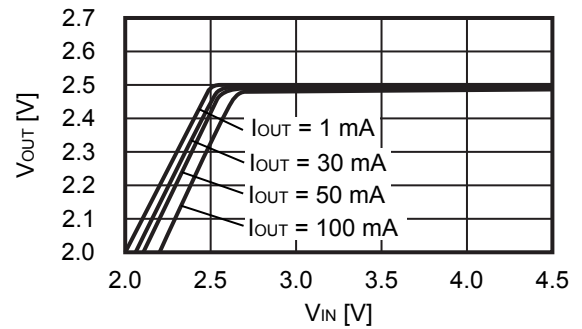

2.3 $V_{\text{OUT}} = 3.5 \text{ V}$

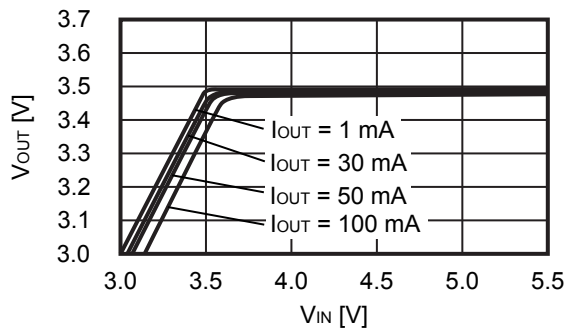

3. 输入输出电压差 – 输出电流

3.1 $V_{OUT} = 1.0\text{ V}$

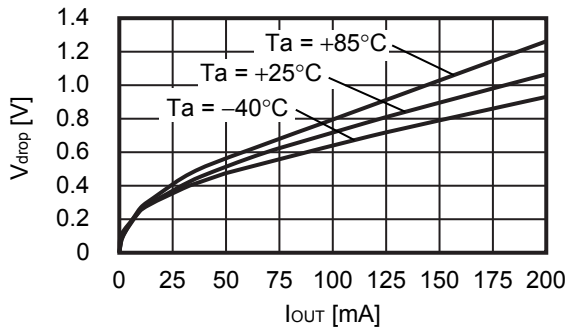

3.2 $V_{OUT} = 2.5\text{ V}$

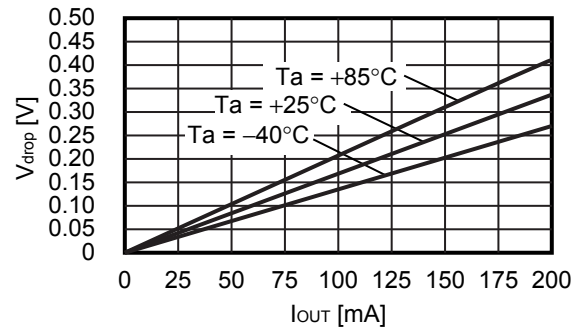

3.3 $V_{OUT} = 3.5\text{ V}$

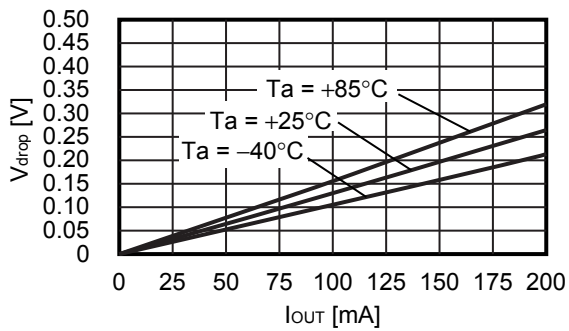

4. 输入输出电压差 – 设定输出电压

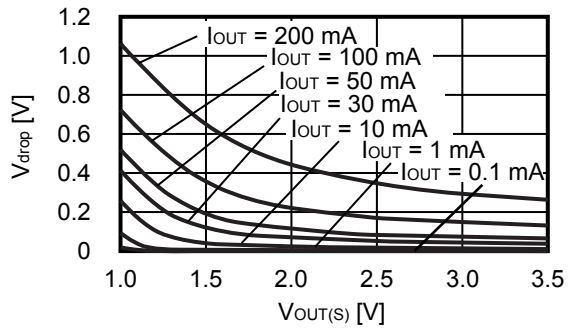

5. 输出电压 – 环境温度

5.1 $V_{OUT} = 1.0\text{ V}$

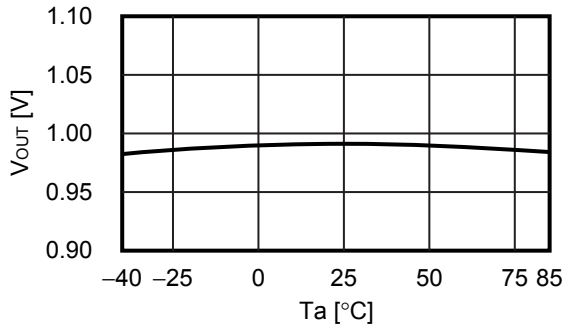

5.2 $V_{OUT} = 2.5\text{ V}$

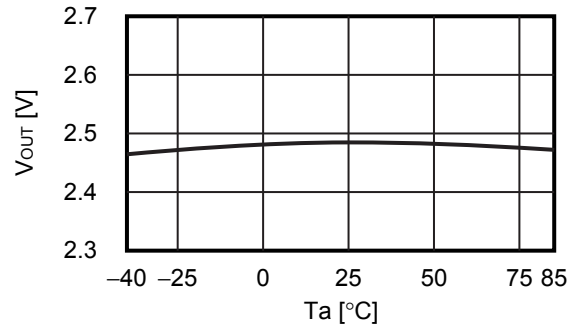

5.3 $V_{OUT} = 3.5\text{ V}$

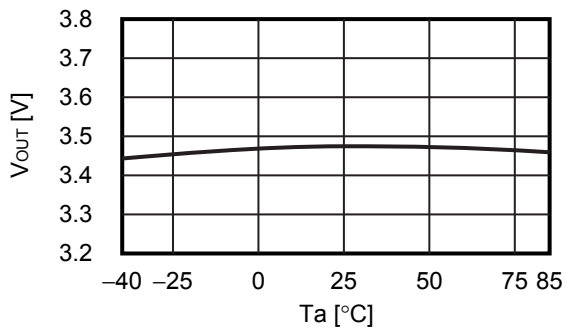

6. 消耗电流 – 输入电压

6.1 $V_{OUT} = 1.0\text{ V}$

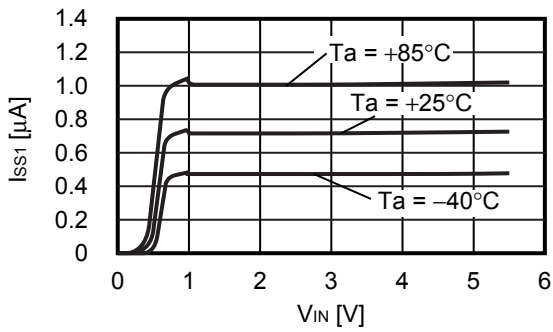

6.2 $V_{OUT} = 2.5\text{ V}$

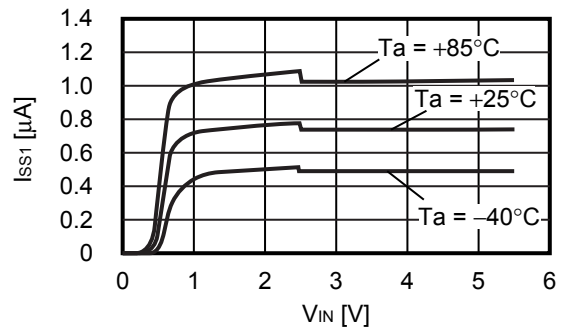

6.3 $V_{OUT} = 3.5\text{ V}$

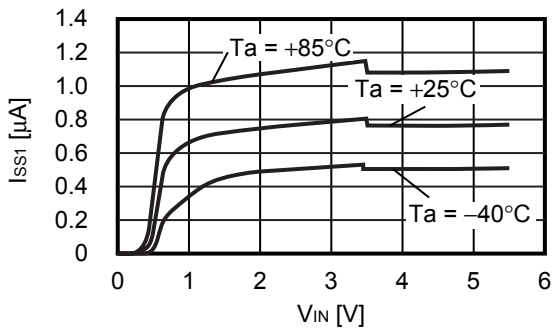

7. 消耗电流 – 环境温度

7.1 $V_{OUT} = 1.0\text{ V}$

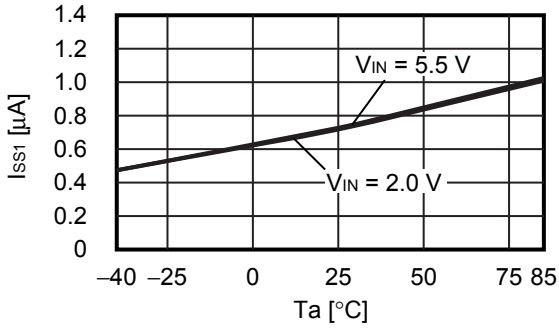

7.2 $V_{OUT} = 2.5\text{ V}$

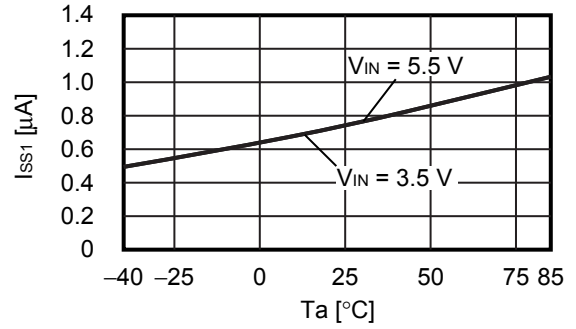

7.3 $V_{OUT} = 3.5\text{ V}$

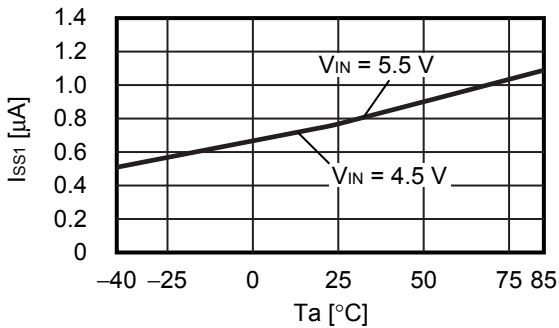

8. 消耗电流 – 输出电流

8.1 $V_{OUT} = 1.0\text{ V}$

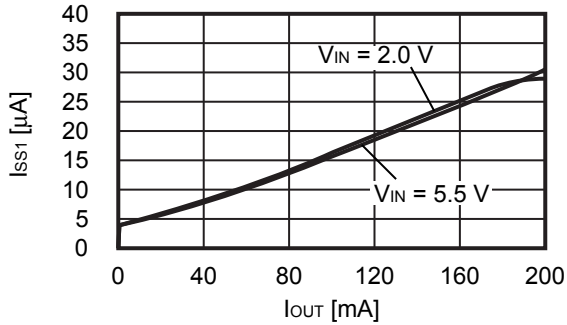

8.2 $V_{OUT} = 2.5\text{ V}$

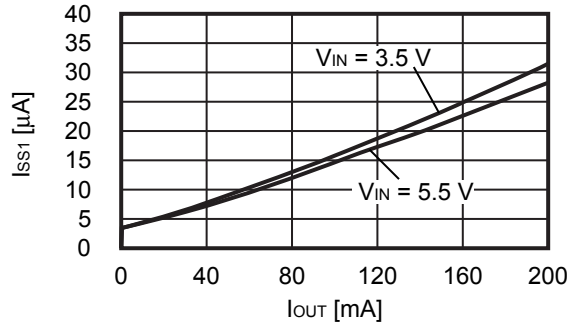

8.3 $V_{OUT} = 3.5\text{ V}$

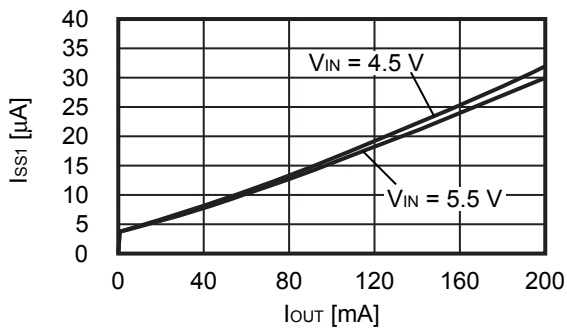

■ 参考数据

1. 输入过渡响应特性 (Ta = +25°C)

1.1 V_{OUT} = 1.0 V

I_{OUT} = 1 mA, C_{IN} = C_L = 0.1 μF, V_{IN} = 2.0 V ↔ 3.0 V, t_r = t_f = 5.0 μs

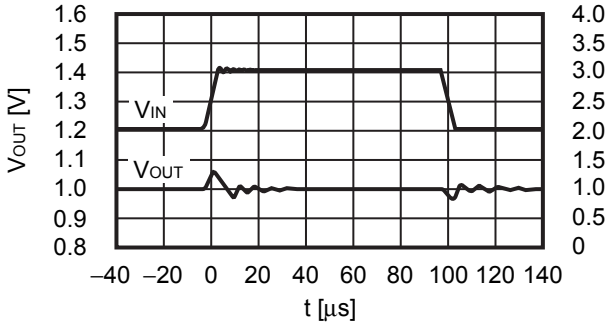

I_{OUT} = 100 mA, C_{IN} = C_L = 0.1 μF, V_{IN} = 2.0 V ↔ 3.0 V, t_r = t_f = 5.0 μs

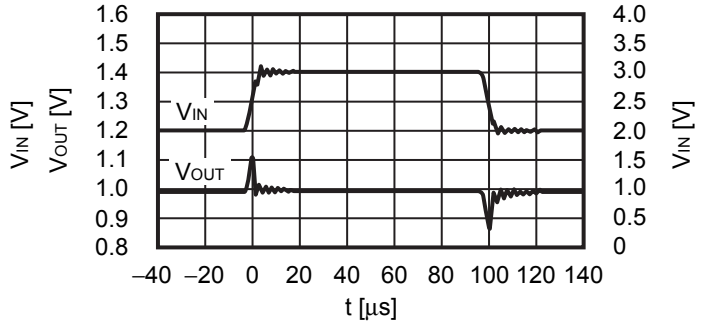

1.2 V_{OUT} = 2.5 V

I_{OUT} = 1 mA, C_{IN} = C_L = 0.1 μF, V_{IN} = 3.5 V ↔ 4.5 V, t_r = t_f = 5.0 μs

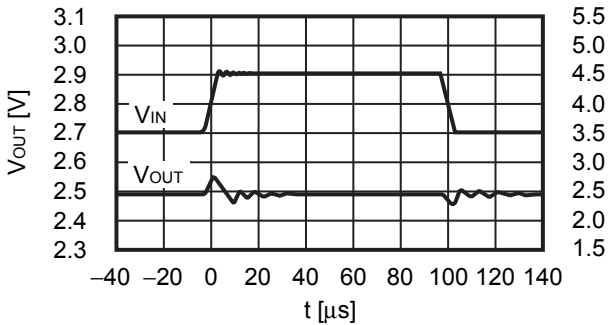

I_{OUT} = 100 mA, C_{IN} = C_L = 0.1 μF, V_{IN} = 3.5 V ↔ 4.5 V, t_r = t_f = 5.0 μs

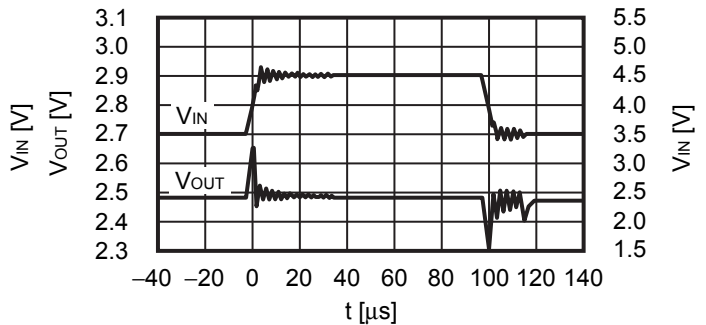

1.3 V_{OUT} = 3.5 V

I_{OUT} = 1 mA, C_{IN} = C_L = 0.1 μF, V_{IN} = 4.5 V ↔ 5.5 V, t_r = t_f = 5.0 μs

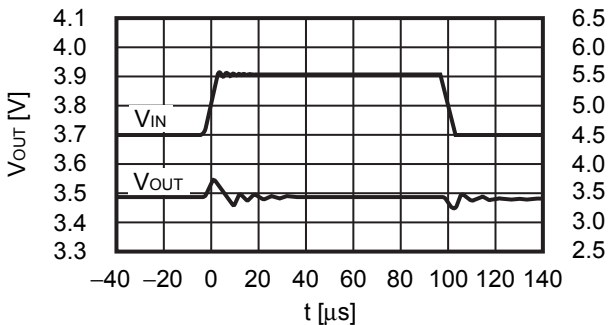

I_{OUT} = 100 mA, C_{IN} = C_L = 0.1 μF, V_{IN} = 4.5 V ↔ 5.5 V, t_r = t_f = 5.0 μs

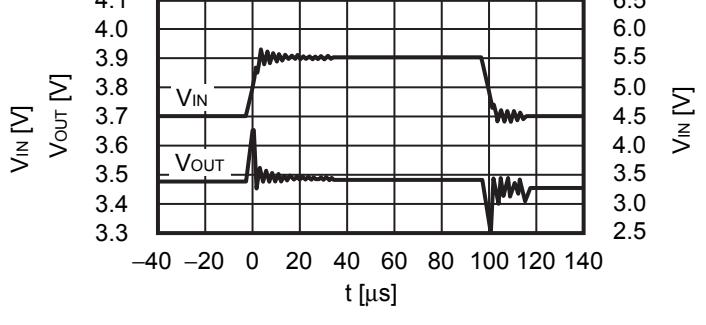

2. 负载过渡响应特性 (Ta = +25°C)

2.1 V_{OUT} = 1.0 V

V_{IN} = 2.0 V, C_{IN} = C_L = 0.1 μF, I_{OUT} = 1 mA ↔ 50 mA

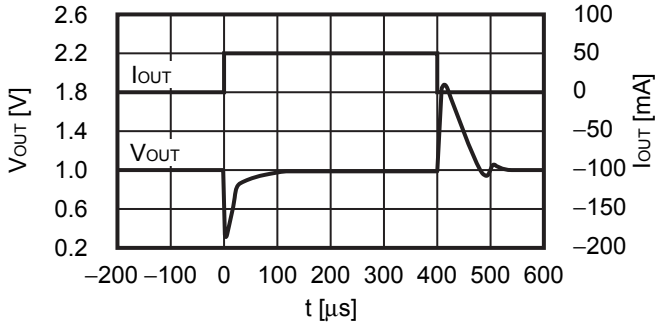

V_{IN} = 2.0 V, C_{IN} = C_L = 0.1 μF, I_{OUT} = 50 mA ↔ 100 mA

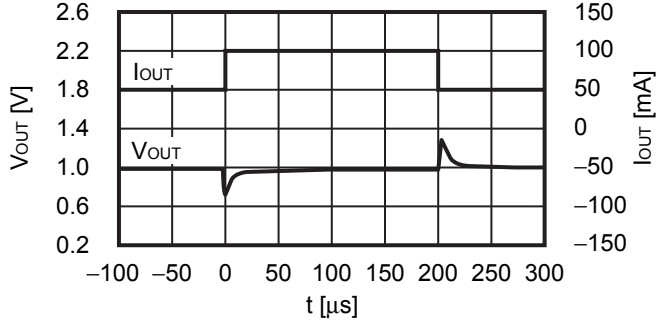

2.2 V_{OUT} = 2.5 V

V_{IN} = 3.5 V, C_{IN} = C_L = 0.1 μF, I_{OUT} = 1 mA ↔ 50 mA

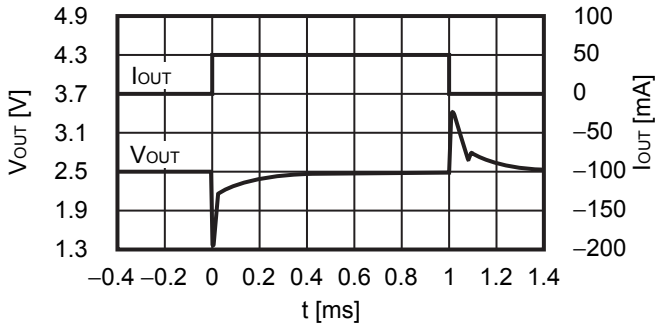

V_{IN} = 3.5 V, C_{IN} = C_L = 0.1 μF, I_{OUT} = 50 mA ↔ 100 mA

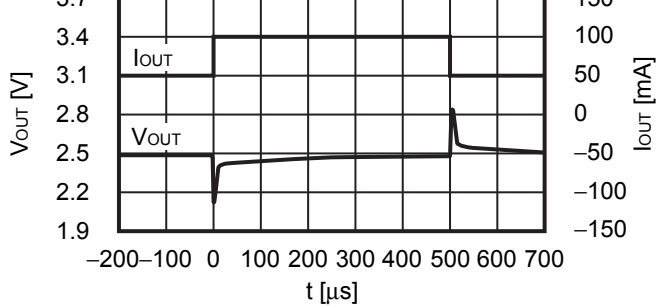

2.3 V_{OUT} = 3.5 V

V_{IN} = 4.5 V, C_{IN} = C_L = 0.1 μF, I_{OUT} = 1 mA ↔ 50 mA

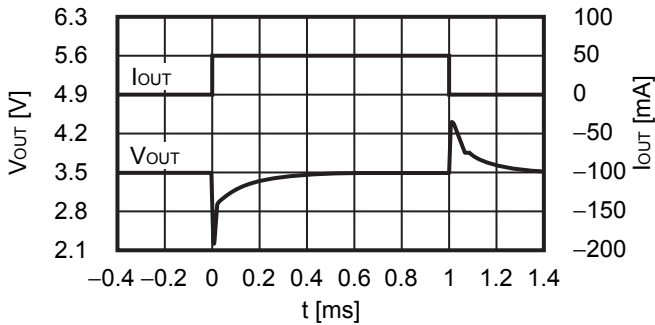

V_{IN} = 4.5 V, C_{IN} = C_L = 0.1 μF, I_{OUT} = 50 mA ↔ 100 mA

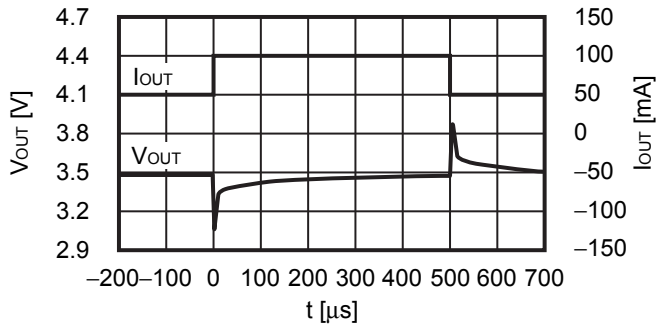

3. ON / OFF端子过渡响应特性 (Ta = +25°C)

3.1 V_{OUT} = 1.0 V

V_{IN} = 2.0 V, C_{IN} = C_L = 0.1 μF, I_{OUT} = 1 mA, V_{ON/OFF} = 0 V → 2 V, t_r = 1.0 μs

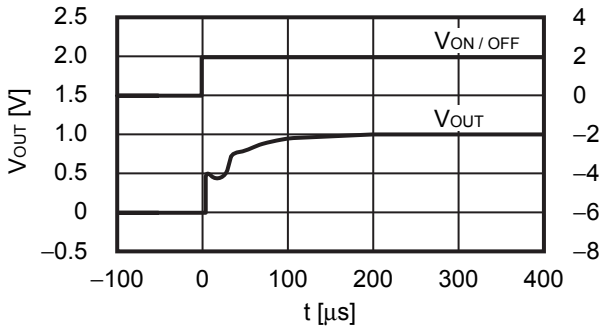

V_{IN} = 2.0 V, C_{IN} = C_L = 0.1 μF, I_{OUT} = 100 mA, V_{ON/OFF} = 0 V → 2 V, t_r = 1.0 μs

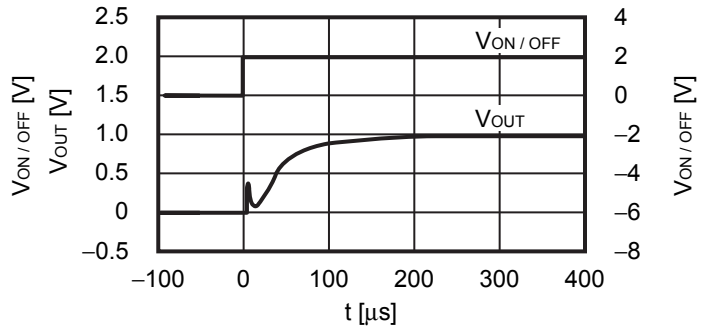

3.2 V_{OUT} = 2.5 V

V_{IN} = 3.5 V, C_{IN} = C_L = 0.1 μF, I_{OUT} = 1 mA, V_{ON/OFF} = 0 V → 3.5 V, t_r = 1.0 μs

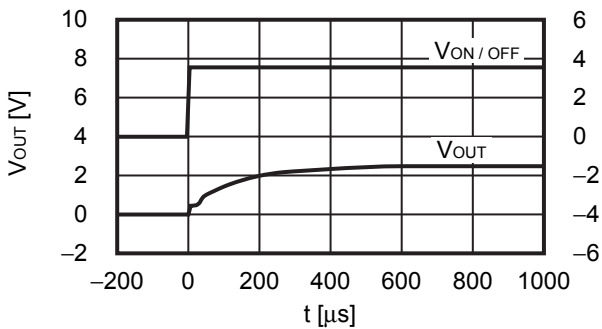

V_{IN} = 3.5 V, C_{IN} = C_L = 0.1 μF, I_{OUT} = 100 mA, V_{ON/OFF} = 0 V → 3.5 V, t_r = 1.0 μs

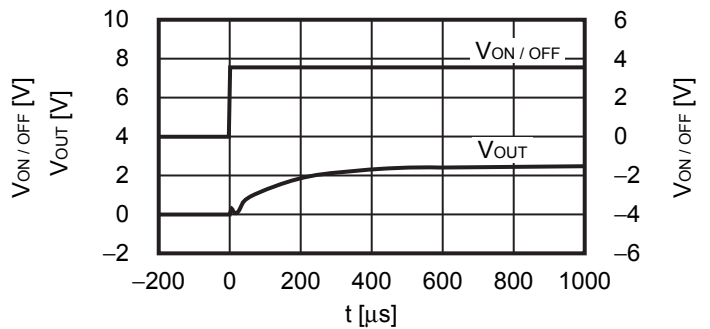

3.3 V_{OUT} = 3.5 V

V_{IN} = 4.5 V, C_{IN} = C_L = 0.1 μF, I_{OUT} = 1 mA, V_{ON/OFF} = 0 V → 4.5 V, t_r = 1.0 μs

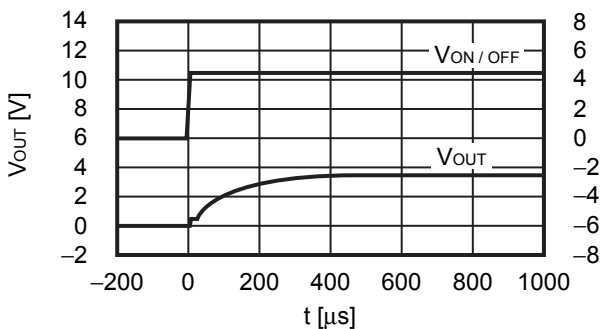

V_{IN} = 4.5 V, C_{IN} = C_L = 0.1 μF, I_{OUT} = 100 mA, V_{ON/OFF} = 0 V → 4.5 V, t_r = 1.0 μs

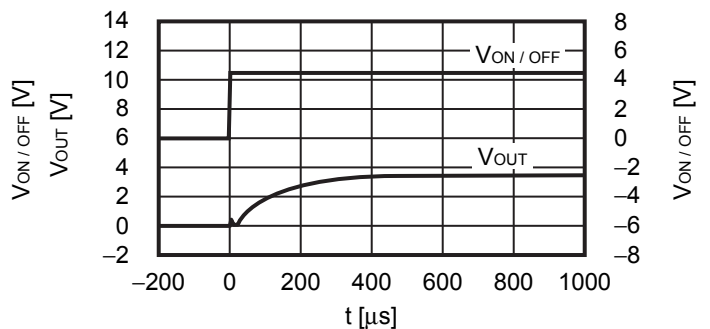

4. 输出电容 – 放电时间特性 (Ta = +25°C)



图22 S-1313系列A/B型
(备有放电分路功能)



图23 放电时间的测定条件

5. 纹波抑制率

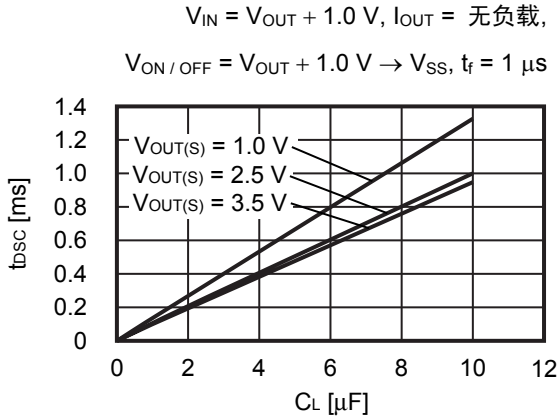
5.1 $V_{OUT} = 1.0\text{ V}$

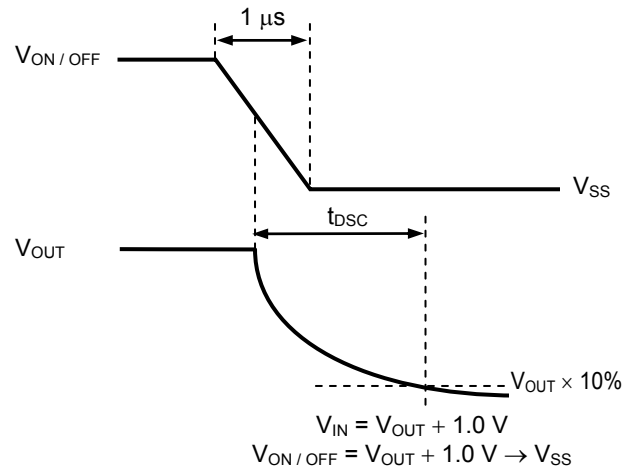
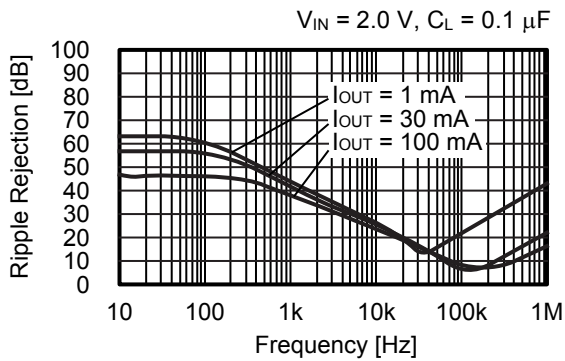

5.2 $V_{OUT} = 2.5\text{ V}$

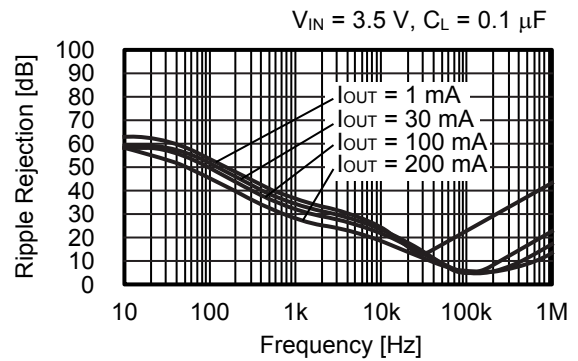

5.3 $V_{OUT} = 3.5\text{ V}$

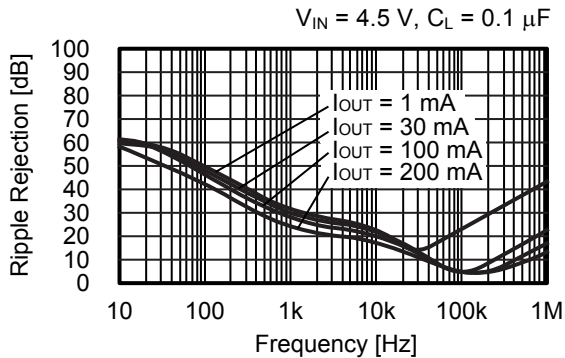

6. 等效串联电阻 – 输出电流特性例 (Ta = +25°C)



图24



图25

■ 标记规格

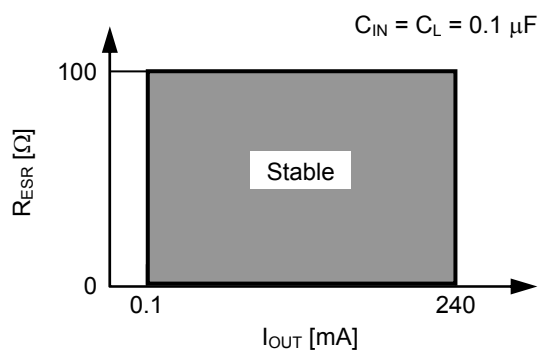
1. SOT-23-5

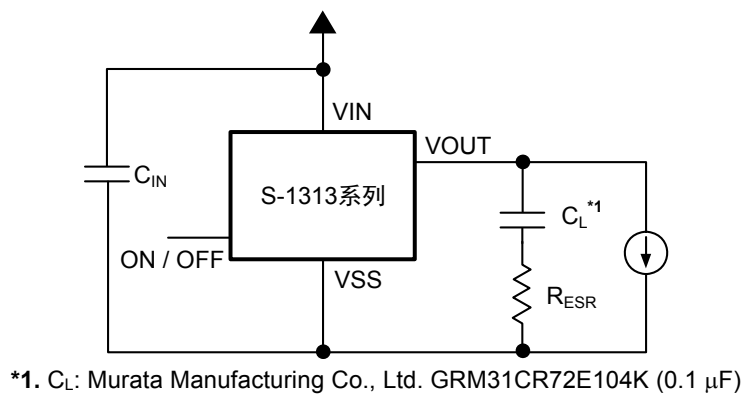
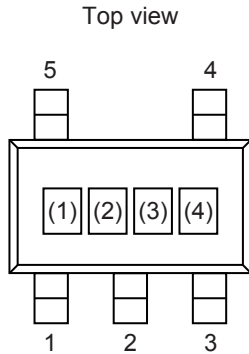

(1) ~ (3): 产品简称 (请参阅产品名与产品简称的对照表)
(4): 批号

产品名与产品简称的对照表

1.1 S-1313系列A型

产品名	产品简称		
	(1)	(2)	(3)
S-1313A10-M5T1U3	1	L	A
S-1313A11-M5T1U3	1	L	B
S-1313A12-M5T1U3	1	L	C
S-1313A13-M5T1U3	1	L	D
S-1313A14-M5T1U3	1	L	E
S-1313A15-M5T1U3	1	L	F
S-1313A16-M5T1U3	1	L	G
S-1313A17-M5T1U3	1	L	H
S-1313A18-M5T1U3	1	L	J
S-1313A1J-M5T1U3	1	L	K
S-1313A19-M5T1U3	1	L	L
S-1313A20-M5T1U3	1	L	N
S-1313A21-M5T1U3	1	L	O
S-1313A22-M5T1U3	1	L	P
S-1313A23-M5T1U3	1	L	Q
S-1313A24-M5T1U3	1	L	R
S-1313A25-M5T1U3	1	L	S
S-1313A26-M5T1U3	1	L	T
S-1313A27-M5T1U3	1	L	V
S-1313A28-M5T1U3	1	L	U
S-1313A2J-M5T1U3	1	L	X
S-1313A29-M5T1U3	1	L	Y
S-1313A30-M5T1U3	1	L	Z
S-1313A31-M5T1U3	1	L	1
S-1313A32-M5T1U3	1	L	2
S-1313A33-M5T1U3	1	L	3
S-1313A34-M5T1U3	1	L	4
S-1313A35-M5T1U3	1	L	5

1.2 S-1313系列B型

产品名	产品简称		
	(1)	(2)	(3)
S-1313B10-M5T1U3	1	N	A
S-1313B11-M5T1U3	1	N	B
S-1313B12-M5T1U3	1	N	C
S-1313B13-M5T1U3	1	N	D
S-1313B14-M5T1U3	1	N	E
S-1313B15-M5T1U3	1	N	F
S-1313B16-M5T1U3	1	N	G
S-1313B17-M5T1U3	1	N	H
S-1313B18-M5T1U3	1	N	J
S-1313B1J-M5T1U3	1	N	K
S-1313B19-M5T1U3	1	N	L
S-1313B20-M5T1U3	1	N	N
S-1313B21-M5T1U3	1	N	O
S-1313B22-M5T1U3	1	N	P
S-1313B23-M5T1U3	1	N	Q
S-1313B24-M5T1U3	1	N	R
S-1313B25-M5T1U3	1	N	S
S-1313B26-M5T1U3	1	N	T
S-1313B27-M5T1U3	1	N	U
S-1313B28-M5T1U3	1	N	V
S-1313B2J-M5T1U3	1	N	X
S-1313B29-M5T1U3	1	N	Y
S-1313B30-M5T1U3	1	N	Z
S-1313B31-M5T1U3	1	N	1
S-1313B32-M5T1U3	1	N	2
S-1313B33-M5T1U3	1	N	3
S-1313B34-M5T1U3	1	N	4
S-1313B35-M5T1U3	1	N	5

1.3 S-1313系列C型

产品名	产品简称		
	(1)	(2)	(3)
S-1313C10-M5T1U3	1	O	A
S-1313C11-M5T1U3	1	O	B
S-1313C12-M5T1U3	1	O	C
S-1313C13-M5T1U3	1	O	D
S-1313C14-M5T1U3	1	O	E
S-1313C15-M5T1U3	1	O	F
S-1313C16-M5T1U3	1	O	G
S-1313C17-M5T1U3	1	O	H
S-1313C18-M5T1U3	1	O	J
S-1313C1J-M5T1U3	1	O	K
S-1313C19-M5T1U3	1	O	L
S-1313C20-M5T1U3	1	O	N
S-1313C21-M5T1U3	1	O	O
S-1313C22-M5T1U3	1	O	P
S-1313C23-M5T1U3	1	O	Q
S-1313C24-M5T1U3	1	O	R
S-1313C25-M5T1U3	1	O	S
S-1313C26-M5T1U3	1	O	T
S-1313C27-M5T1U3	1	O	U
S-1313C28-M5T1U3	1	O	V
S-1313C2J-M5T1U3	1	O	X
S-1313C29-M5T1U3	1	O	Y
S-1313C30-M5T1U3	1	O	Z
S-1313C31-M5T1U3	1	O	1
S-1313C32-M5T1U3	1	O	2
S-1313C33-M5T1U3	1	O	3
S-1313C34-M5T1U3	1	O	4
S-1313C35-M5T1U3	1	O	5

1.4 S-1313系列D型

产品名	产品简称		
	(1)	(2)	(3)
S-1313D10-M5T1U3	1	P	A
S-1313D11-M5T1U3	1	P	B
S-1313D12-M5T1U3	1	P	C
S-1313D13-M5T1U3	1	P	D
S-1313D14-M5T1U3	1	P	E
S-1313D15-M5T1U3	1	P	F
S-1313D16-M5T1U3	1	P	G
S-1313D17-M5T1U3	1	P	H
S-1313D18-M5T1U3	1	P	J
S-1313D1J-M5T1U3	1	P	K
S-1313D19-M5T1U3	1	P	L
S-1313D20-M5T1U3	1	P	N
S-1313D21-M5T1U3	1	P	O
S-1313D22-M5T1U3	1	P	P
S-1313D23-M5T1U3	1	P	Q
S-1313D24-M5T1U3	1	P	R
S-1313D25-M5T1U3	1	P	S
S-1313D26-M5T1U3	1	P	T
S-1313D27-M5T1U3	1	P	U
S-1313D28-M5T1U3	1	P	V
S-1313D2J-M5T1U3	1	P	X
S-1313D29-M5T1U3	1	P	Y
S-1313D30-M5T1U3	1	P	Z
S-1313D31-M5T1U3	1	P	1
S-1313D32-M5T1U3	1	P	2
S-1313D33-M5T1U3	1	P	3
S-1313D34-M5T1U3	1	P	4
S-1313D35-M5T1U3	1	P	5

2. SC-82AB

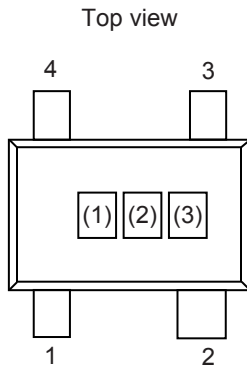

(1) ~ (3): 产品简称 (请参阅产品名与产品简称的对照表)

产品名与产品简称的对照表

2.1 S-1313系列A型

产品名	产品简称		
	(1)	(2)	(3)
S-1313A10-N4T1U3	1	L	A
S-1313A11-N4T1U3	1	L	B
S-1313A12-N4T1U3	1	L	C
S-1313A13-N4T1U3	1	L	D
S-1313A14-N4T1U3	1	L	E
S-1313A15-N4T1U3	1	L	F
S-1313A16-N4T1U3	1	L	G
S-1313A17-N4T1U3	1	L	H
S-1313A18-N4T1U3	1	L	J
S-1313A1J-N4T1U3	1	L	K
S-1313A19-N4T1U3	1	L	L
S-1313A20-N4T1U3	1	L	N
S-1313A21-N4T1U3	1	L	O
S-1313A22-N4T1U3	1	L	P
S-1313A23-N4T1U3	1	L	Q
S-1313A24-N4T1U3	1	L	R
S-1313A25-N4T1U3	1	L	S
S-1313A26-N4T1U3	1	L	T
S-1313A27-N4T1U3	1	L	V
S-1313A28-N4T1U3	1	L	U
S-1313A2J-N4T1U3	1	L	X
S-1313A29-N4T1U3	1	L	Y
S-1313A30-N4T1U3	1	L	Z
S-1313A31-N4T1U3	1	L	1
S-1313A32-N4T1U3	1	L	2
S-1313A33-N4T1U3	1	L	3
S-1313A34-N4T1U3	1	L	4
S-1313A35-N4T1U3	1	L	5

2.2 S-1313系列B型

产品名	产品简称		
	(1)	(2)	(3)
S-1313B10-N4T1U3	1	N	A
S-1313B11-N4T1U3	1	N	B
S-1313B12-N4T1U3	1	N	C
S-1313B13-N4T1U3	1	N	D
S-1313B14-N4T1U3	1	N	E
S-1313B15-N4T1U3	1	N	F
S-1313B16-N4T1U3	1	N	G
S-1313B17-N4T1U3	1	N	H
S-1313B18-N4T1U3	1	N	J
S-1313B1J-N4T1U3	1	N	K
S-1313B19-N4T1U3	1	N	L
S-1313B20-N4T1U3	1	N	N
S-1313B21-N4T1U3	1	N	O
S-1313B22-N4T1U3	1	N	P
S-1313B23-N4T1U3	1	N	Q
S-1313B24-N4T1U3	1	N	R
S-1313B25-N4T1U3	1	N	S
S-1313B26-N4T1U3	1	N	T
S-1313B27-N4T1U3	1	N	U
S-1313B28-N4T1U3	1	N	V
S-1313B2J-N4T1U3	1	N	X
S-1313B29-N4T1U3	1	N	Y
S-1313B30-N4T1U3	1	N	Z
S-1313B31-N4T1U3	1	N	1
S-1313B32-N4T1U3	1	N	2
S-1313B33-N4T1U3	1	N	3
S-1313B34-N4T1U3	1	N	4
S-1313B35-N4T1U3	1	N	5

2.3 S-1313系列C型

产品名	产品简称		
	(1)	(2)	(3)
S-1313C10-N4T1U3	1	O	A
S-1313C11-N4T1U3	1	O	B
S-1313C12-N4T1U3	1	O	C
S-1313C13-N4T1U3	1	O	D
S-1313C14-N4T1U3	1	O	E
S-1313C15-N4T1U3	1	O	F
S-1313C16-N4T1U3	1	O	G
S-1313C17-N4T1U3	1	O	H
S-1313C18-N4T1U3	1	O	J
S-1313C1J-N4T1U3	1	O	K
S-1313C19-N4T1U3	1	O	L
S-1313C20-N4T1U3	1	O	N
S-1313C21-N4T1U3	1	O	O
S-1313C22-N4T1U3	1	O	P
S-1313C23-N4T1U3	1	O	Q
S-1313C24-N4T1U3	1	O	R
S-1313C25-N4T1U3	1	O	S
S-1313C26-N4T1U3	1	O	T
S-1313C27-N4T1U3	1	O	U
S-1313C28-N4T1U3	1	O	V
S-1313C2J-N4T1U3	1	O	X
S-1313C29-N4T1U3	1	O	Y
S-1313C30-N4T1U3	1	O	Z
S-1313C31-N4T1U3	1	O	1
S-1313C32-N4T1U3	1	O	2
S-1313C33-N4T1U3	1	O	3
S-1313C34-N4T1U3	1	O	4
S-1313C35-N4T1U3	1	O	5

2.4 S-1313系列D型

产品名	产品简称		
	(1)	(2)	(3)
S-1313D10-N4T1U3	1	P	A
S-1313D11-N4T1U3	1	P	B
S-1313D12-N4T1U3	1	P	C
S-1313D13-N4T1U3	1	P	D
S-1313D14-N4T1U3	1	P	E
S-1313D15-N4T1U3	1	P	F
S-1313D16-N4T1U3	1	P	G
S-1313D17-N4T1U3	1	P	H
S-1313D18-N4T1U3	1	P	J
S-1313D1J-N4T1U3	1	P	K
S-1313D19-N4T1U3	1	P	L
S-1313D20-N4T1U3	1	P	N
S-1313D21-N4T1U3	1	P	O
S-1313D22-N4T1U3	1	P	P
S-1313D23-N4T1U3	1	P	Q
S-1313D24-N4T1U3	1	P	R
S-1313D25-N4T1U3	1	P	S
S-1313D26-N4T1U3	1	P	T
S-1313D27-N4T1U3	1	P	U
S-1313D28-N4T1U3	1	P	V
S-1313D2J-N4T1U3	1	P	X
S-1313D29-N4T1U3	1	P	Y
S-1313D30-N4T1U3	1	P	Z
S-1313D31-N4T1U3	1	P	1
S-1313D32-N4T1U3	1	P	2
S-1313D33-N4T1U3	1	P	3
S-1313D34-N4T1U3	1	P	4
S-1313D35-N4T1U3	1	P	5

3. HSNT-4 (1010)

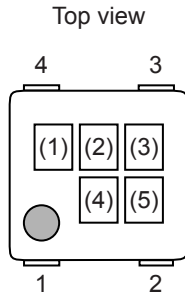

(1) ~ (3) : 产品简称 (请参阅产品名与产品简称的对照表)
(4)、(5) : 批号

产品名与产品简称的对照表

3.1 S-1313系列A型

产品名	产品简称		
	(1)	(2)	(3)
S-1313A10-A4T2U3	1	L	A
S-1313A11-A4T2U3	1	L	B
S-1313A12-A4T2U3	1	L	C
S-1313A13-A4T2U3	1	L	D
S-1313A14-A4T2U3	1	L	E
S-1313A15-A4T2U3	1	L	F
S-1313A16-A4T2U3	1	L	G
S-1313A17-A4T2U3	1	L	H
S-1313A18-A4T2U3	1	L	J
S-1313A1J-A4T2U3	1	L	K
S-1313A19-A4T2U3	1	L	L
S-1313A20-A4T2U3	1	L	N
S-1313A21-A4T2U3	1	L	O
S-1313A22-A4T2U3	1	L	P
S-1313A23-A4T2U3	1	L	Q
S-1313A24-A4T2U3	1	L	R
S-1313A25-A4T2U3	1	L	S
S-1313A26-A4T2U3	1	L	T
S-1313A27-A4T2U3	1	L	V
S-1313A28-A4T2U3	1	L	U
S-1313A2J-A4T2U3	1	L	X
S-1313A29-A4T2U3	1	L	Y
S-1313A30-A4T2U3	1	L	Z
S-1313A31-A4T2U3	1	L	1
S-1313A32-A4T2U3	1	L	2
S-1313A33-A4T2U3	1	L	3
S-1313A34-A4T2U3	1	L	4
S-1313A35-A4T2U3	1	L	5

3.2 S-1313系列B型

产品名	产品简称		
	(1)	(2)	(3)
S-1313B10-A4T2U3	1	N	A
S-1313B11-A4T2U3	1	N	B
S-1313B12-A4T2U3	1	N	C
S-1313B13-A4T2U3	1	N	D
S-1313B14-A4T2U3	1	N	E
S-1313B15-A4T2U3	1	N	F
S-1313B16-A4T2U3	1	N	G
S-1313B17-A4T2U3	1	N	H
S-1313B18-A4T2U3	1	N	J
S-1313B1J-A4T2U3	1	N	K
S-1313B19-A4T2U3	1	N	L
S-1313B20-A4T2U3	1	N	N
S-1313B21-A4T2U3	1	N	O
S-1313B22-A4T2U3	1	N	P
S-1313B23-A4T2U3	1	N	Q
S-1313B24-A4T2U3	1	N	R
S-1313B25-A4T2U3	1	N	S
S-1313B26-A4T2U3	1	N	T
S-1313B27-A4T2U3	1	N	U
S-1313B28-A4T2U3	1	N	V
S-1313B2J-A4T2U3	1	N	X
S-1313B29-A4T2U3	1	N	Y
S-1313B30-A4T2U3	1	N	Z
S-1313B31-A4T2U3	1	N	1
S-1313B32-A4T2U3	1	N	2
S-1313B33-A4T2U3	1	N	3
S-1313B34-A4T2U3	1	N	4
S-1313B35-A4T2U3	1	N	5

3.3 S-1313系列C型

产品名	产品简称		
	(1)	(2)	(3)
S-1313C10-A4T2U3	1	O	A
S-1313C11-A4T2U3	1	O	B
S-1313C12-A4T2U3	1	O	C
S-1313C13-A4T2U3	1	O	D
S-1313C14-A4T2U3	1	O	E
S-1313C15-A4T2U3	1	O	F
S-1313C16-A4T2U3	1	O	G
S-1313C17-A4T2U3	1	O	H
S-1313C18-A4T2U3	1	O	J
S-1313C1J-A4T2U3	1	O	K
S-1313C19-A4T2U3	1	O	L
S-1313C20-A4T2U3	1	O	N
S-1313C21-A4T2U3	1	O	O
S-1313C22-A4T2U3	1	O	P
S-1313C23-A4T2U3	1	O	Q
S-1313C24-A4T2U3	1	O	R
S-1313C25-A4T2U3	1	O	S
S-1313C26-A4T2U3	1	O	T
S-1313C27-A4T2U3	1	O	U
S-1313C28-A4T2U3	1	O	V
S-1313C2J-A4T2U3	1	O	X
S-1313C29-A4T2U3	1	O	Y
S-1313C30-A4T2U3	1	O	Z
S-1313C31-A4T2U3	1	O	1
S-1313C32-A4T2U3	1	O	2
S-1313C33-A4T2U3	1	O	3
S-1313C34-A4T2U3	1	O	4
S-1313C35-A4T2U3	1	O	5

3.4 S-1313系列D型

产品名	产品简称		
	(1)	(2)	(3)
S-1313D10-A4T2U3	1	P	A
S-1313D11-A4T2U3	1	P	B
S-1313D12-A4T2U3	1	P	C
S-1313D13-A4T2U3	1	P	D
S-1313D14-A4T2U3	1	P	E
S-1313D15-A4T2U3	1	P	F
S-1313D16-A4T2U3	1	P	G
S-1313D17-A4T2U3	1	P	H
S-1313D18-A4T2U3	1	P	J
S-1313D1J-A4T2U3	1	P	K
S-1313D19-A4T2U3	1	P	L
S-1313D20-A4T2U3	1	P	N
S-1313D21-A4T2U3	1	P	O
S-1313D22-A4T2U3	1	P	P
S-1313D23-A4T2U3	1	P	Q
S-1313D24-A4T2U3	1	P	R
S-1313D25-A4T2U3	1	P	S
S-1313D26-A4T2U3	1	P	T
S-1313D27-A4T2U3	1	P	U
S-1313D28-A4T2U3	1	P	V
S-1313D2J-A4T2U3	1	P	X
S-1313D29-A4T2U3	1	P	Y
S-1313D30-A4T2U3	1	P	Z
S-1313D31-A4T2U3	1	P	1
S-1313D32-A4T2U3	1	P	2
S-1313D33-A4T2U3	1	P	3
S-1313D34-A4T2U3	1	P	4
S-1313D35-A4T2U3	1	P	5

4. HSNT-4 (0808)

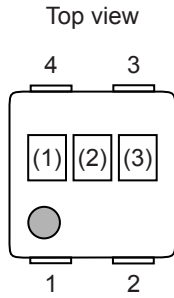

(1) ~ (3) : 产品简称 (请参阅产品名与产品简称的对照表)

产品名与产品简称的对照表

4.1 S-1313系列A型

产品名	产品简称		
	(1)	(2)	(3)
S-1313A10-A4T1U3	1	L	A
S-1313A11-A4T1U3	1	L	B
S-1313A12-A4T1U3	1	L	C
S-1313A13-A4T1U3	1	L	D
S-1313A14-A4T1U3	1	L	E
S-1313A15-A4T1U3	1	L	F
S-1313A16-A4T1U3	1	L	G
S-1313A17-A4T1U3	1	L	H
S-1313A18-A4T1U3	1	L	J
S-1313A1J-A4T1U3	1	L	K
S-1313A19-A4T1U3	1	L	L
S-1313A20-A4T1U3	1	L	N
S-1313A21-A4T1U3	1	L	O
S-1313A22-A4T1U3	1	L	P
S-1313A23-A4T1U3	1	L	Q
S-1313A24-A4T1U3	1	L	R
S-1313A25-A4T1U3	1	L	S
S-1313A26-A4T1U3	1	L	T
S-1313A27-A4T1U3	1	L	V
S-1313A28-A4T1U3	1	L	U
S-1313A2J-A4T1U3	1	L	X
S-1313A29-A4T1U3	1	L	Y
S-1313A30-A4T1U3	1	L	Z
S-1313A31-A4T1U3	1	L	1
S-1313A32-A4T1U3	1	L	2
S-1313A33-A4T1U3	1	L	3
S-1313A34-A4T1U3	1	L	4
S-1313A35-A4T1U3	1	L	5

4.2 S-1313系列B型

产品名	产品简称		
	(1)	(2)	(3)
S-1313B10-A4T1U3	1	N	A
S-1313B11-A4T1U3	1	N	B
S-1313B12-A4T1U3	1	N	C
S-1313B13-A4T1U3	1	N	D
S-1313B14-A4T1U3	1	N	E
S-1313B15-A4T1U3	1	N	F
S-1313B16-A4T1U3	1	N	G
S-1313B17-A4T1U3	1	N	H
S-1313B18-A4T1U3	1	N	J
S-1313B1J-A4T1U3	1	N	K
S-1313B19-A4T1U3	1	N	L
S-1313B20-A4T1U3	1	N	N
S-1313B21-A4T1U3	1	N	O
S-1313B22-A4T1U3	1	N	P
S-1313B23-A4T1U3	1	N	Q
S-1313B24-A4T1U3	1	N	R
S-1313B25-A4T1U3	1	N	S
S-1313B26-A4T1U3	1	N	T
S-1313B27-A4T1U3	1	N	U
S-1313B28-A4T1U3	1	N	V
S-1313B2J-A4T1U3	1	N	X
S-1313B29-A4T1U3	1	N	Y
S-1313B30-A4T1U3	1	N	Z
S-1313B31-A4T1U3	1	N	1
S-1313B32-A4T1U3	1	N	2
S-1313B33-A4T1U3	1	N	3
S-1313B34-A4T1U3	1	N	4
S-1313B35-A4T1U3	1	N	5

4.3 S-1313系列C型

产品名	产品简称		
	(1)	(2)	(3)
S-1313C10-A4T1U3	1	O	A
S-1313C11-A4T1U3	1	O	B
S-1313C12-A4T1U3	1	O	C
S-1313C13-A4T1U3	1	O	D
S-1313C14-A4T1U3	1	O	E
S-1313C15-A4T1U3	1	O	F
S-1313C16-A4T1U3	1	O	G
S-1313C17-A4T1U3	1	O	H
S-1313C18-A4T1U3	1	O	J
S-1313C1J-A4T1U3	1	O	K
S-1313C19-A4T1U3	1	O	L
S-1313C20-A4T1U3	1	O	N
S-1313C21-A4T1U3	1	O	O
S-1313C22-A4T1U3	1	O	P
S-1313C23-A4T1U3	1	O	Q
S-1313C24-A4T1U3	1	O	R
S-1313C25-A4T1U3	1	O	S
S-1313C26-A4T1U3	1	O	T
S-1313C27-A4T1U3	1	O	U
S-1313C28-A4T1U3	1	O	V
S-1313C2J-A4T1U3	1	O	X
S-1313C29-A4T1U3	1	O	Y
S-1313C30-A4T1U3	1	O	Z
S-1313C31-A4T1U3	1	O	1
S-1313C32-A4T1U3	1	O	2
S-1313C33-A4T1U3	1	O	3
S-1313C34-A4T1U3	1	O	4
S-1313C35-A4T1U3	1	O	5

4.4 S-1313系列D型

产品名	产品简称		
	(1)	(2)	(3)
S-1313D10-A4T1U3	1	P	A
S-1313D11-A4T1U3	1	P	B
S-1313D12-A4T1U3	1	P	C
S-1313D13-A4T1U3	1	P	D
S-1313D14-A4T1U3	1	P	E
S-1313D15-A4T1U3	1	P	F
S-1313D16-A4T1U3	1	P	G
S-1313D17-A4T1U3	1	P	H
S-1313D18-A4T1U3	1	P	J
S-1313D1J-A4T1U3	1	P	K
S-1313D19-A4T1U3	1	P	L
S-1313D20-A4T1U3	1	P	N
S-1313D21-A4T1U3	1	P	O
S-1313D22-A4T1U3	1	P	P
S-1313D23-A4T1U3	1	P	Q
S-1313D24-A4T1U3	1	P	R
S-1313D25-A4T1U3	1	P	S
S-1313D26-A4T1U3	1	P	T
S-1313D27-A4T1U3	1	P	U
S-1313D28-A4T1U3	1	P	V
S-1313D2J-A4T1U3	1	P	X
S-1313D29-A4T1U3	1	P	Y
S-1313D30-A4T1U3	1	P	Z
S-1313D31-A4T1U3	1	P	1
S-1313D32-A4T1U3	1	P	2
S-1313D33-A4T1U3	1	P	3
S-1313D34-A4T1U3	1	P	4
S-1313D35-A4T1U3	1	P	5

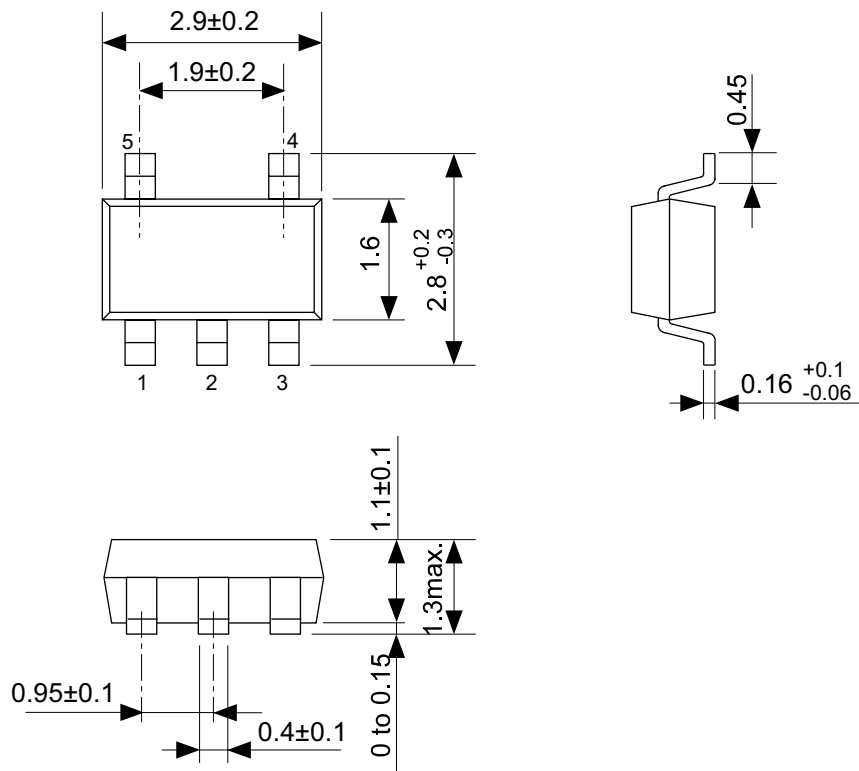

No. MP005-A-P-SD-1.2

TITLE	SOT235-A-PKG Dimensions
No.	MP005-A-P-SD-1.2
SCALE	
UNIT	mm
SII Semiconductor Corporation	

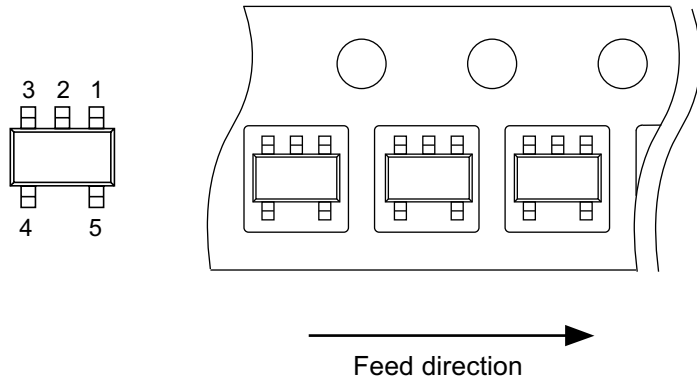
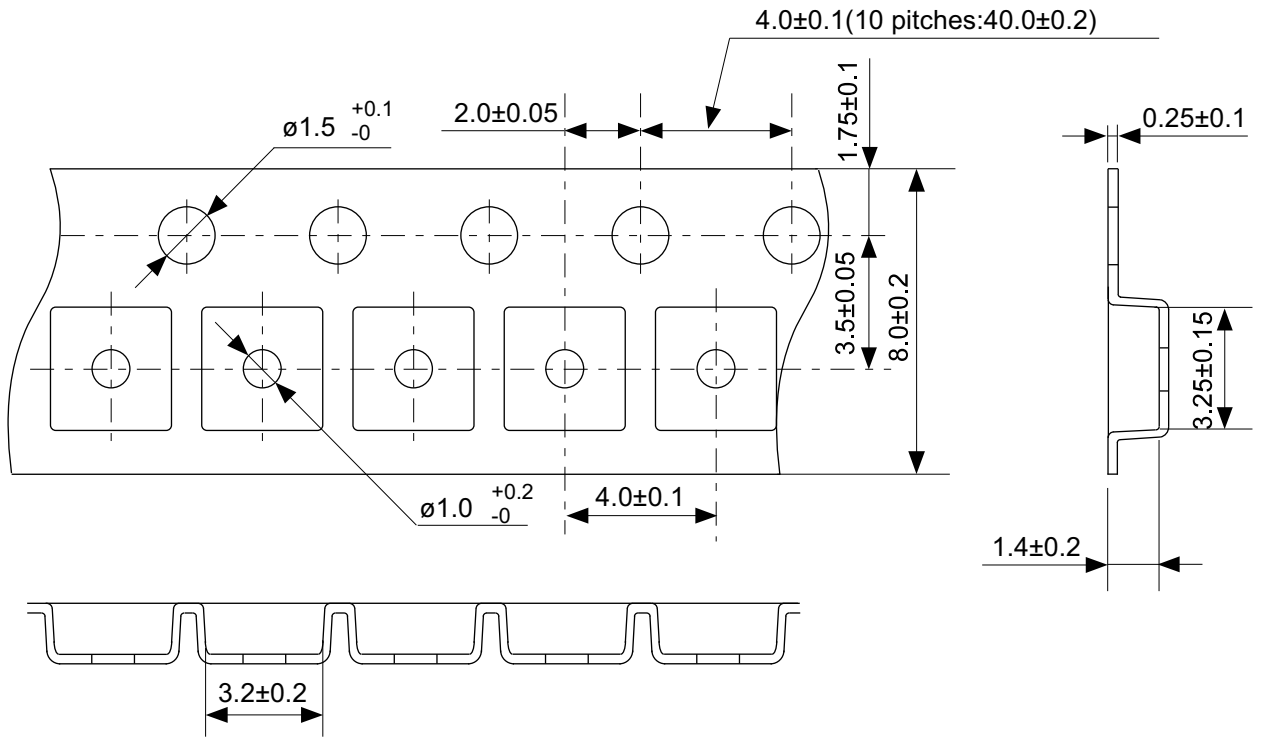

No. MP005-A-C-SD-2.1

TITLE	SOT235-A-Carrier Tape
No.	MP005-A-C-SD-2.1
SCALE	
UNIT	mm
SII Semiconductor Corporation	

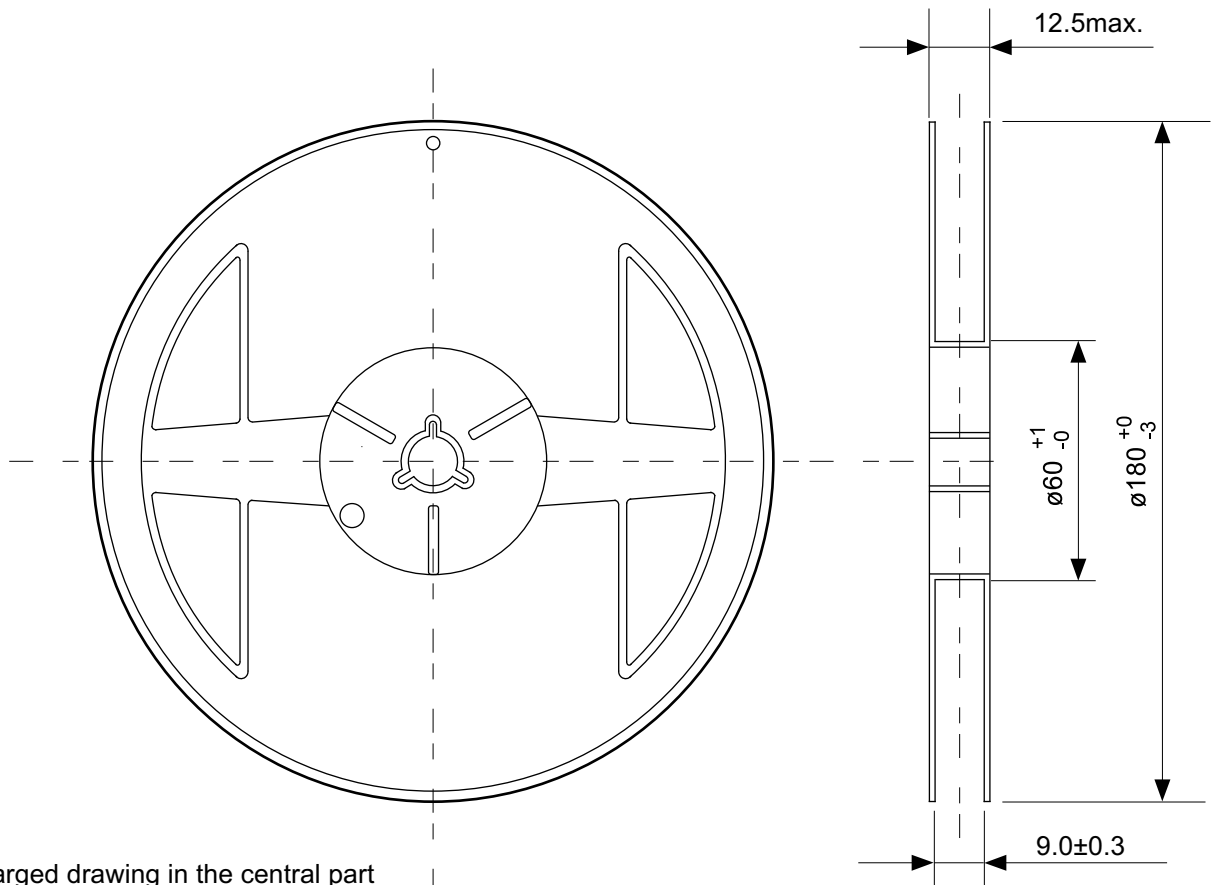

Enlarged drawing in the central part

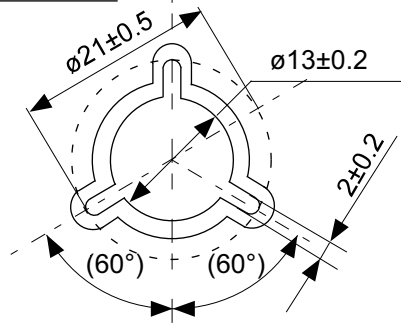

No. MP005-A-R-SD-1.1

TITLE	SOT235-A-Reel		
No.	MP005-A-R-SD-1.1		
SCALE		QTY.	3,000
UNIT	mm		
SII Semiconductor Corporation			

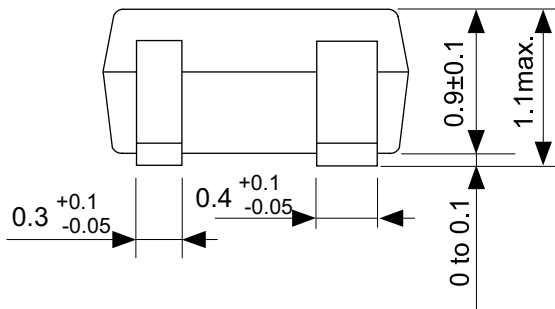
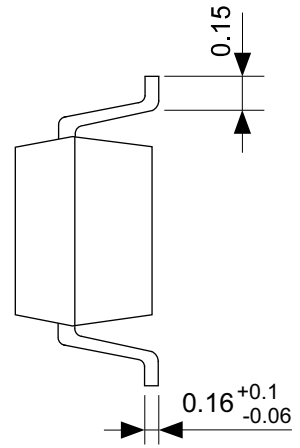

No. NP004-A-P-SD-1.1

TITLE	SC82AB-A-PKG Dimensions
No.	NP004-A-P-SD-1.1
SCALE	
UNIT	mm
SII Semiconductor Corporation	



No. NP004-A-C-SD-3.0

TITLE	SC82AB-A-Carrier Tape
No.	NP004-A-C-SD-3.0
SCALE	
UNIT	mm
SII Semiconductor Corporation	

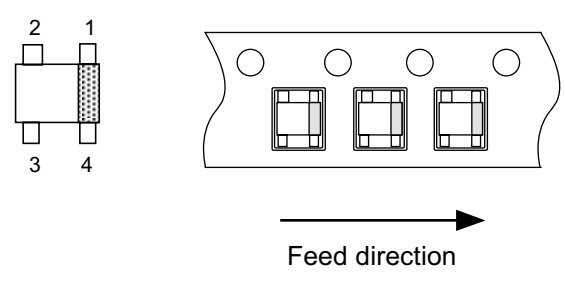

No. NP004-A-C-S1-2.0

TITLE	SC82AB-A-Carrier Tape
No.	NP004-A-C-S1-2.0
SCALE	
UNIT	mm
SII Semiconductor Corporation	

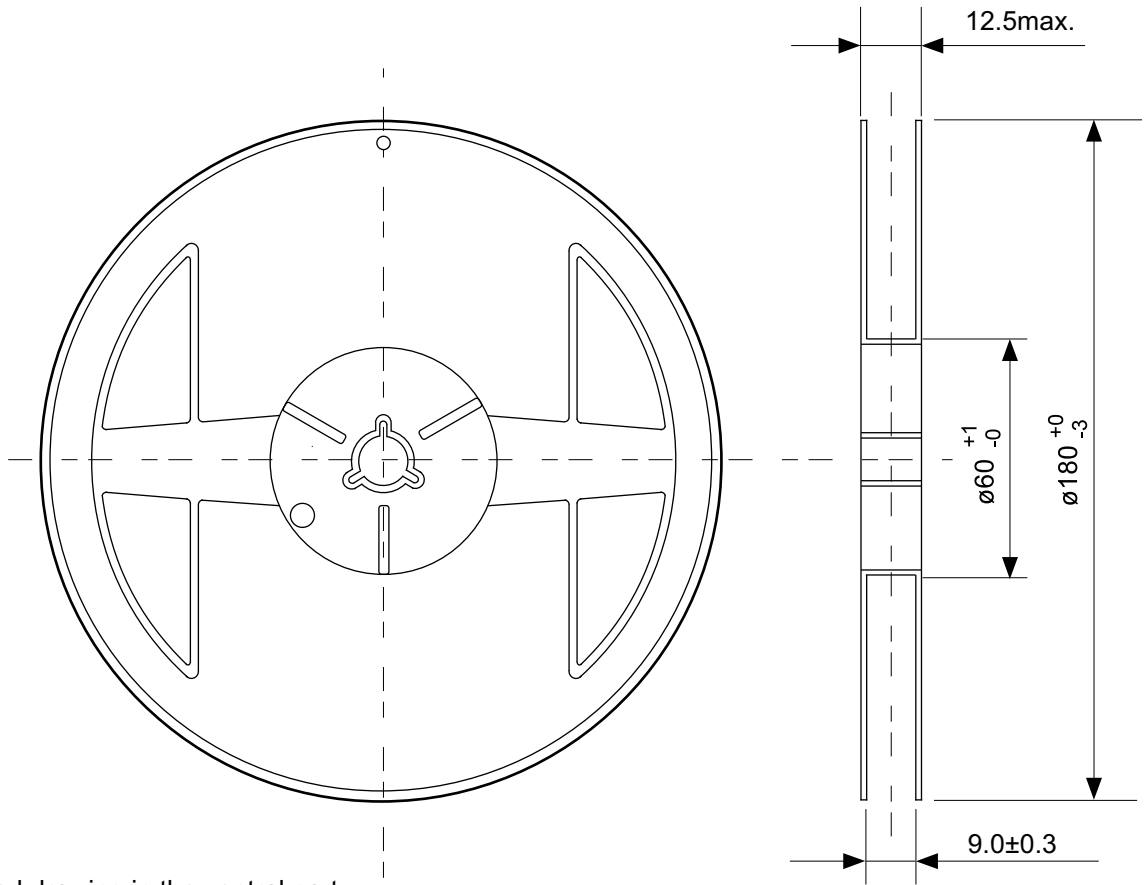

Enlarged drawing in the central part



No. NP004-A-R-SD-1.1

TITLE	SC82AB-A-Reel		
No.	NP004-A-R-SD-1.1		
SCALE		QTY.	3,000
UNIT	mm		
SII Semiconductor Corporation			

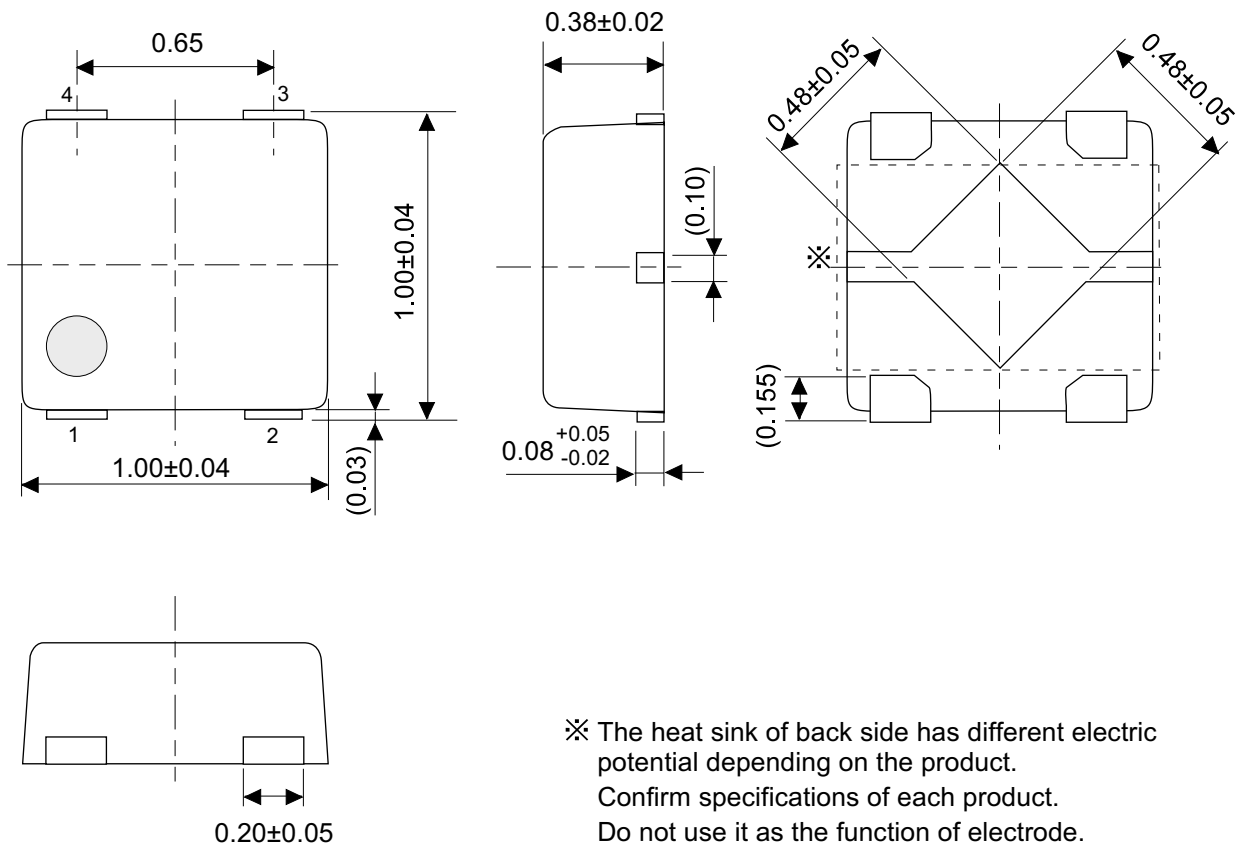

No. PL004-A-P-SD-1.0

TITLE	HSNT-4-B-PKG Dimensions
No.	PL004-A-P-SD-1.0
SCALE	
UNIT	mm
SII Semiconductor Corporation	

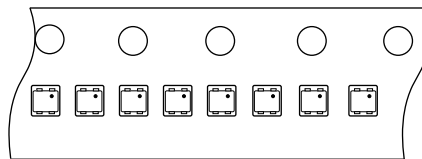
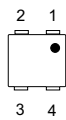
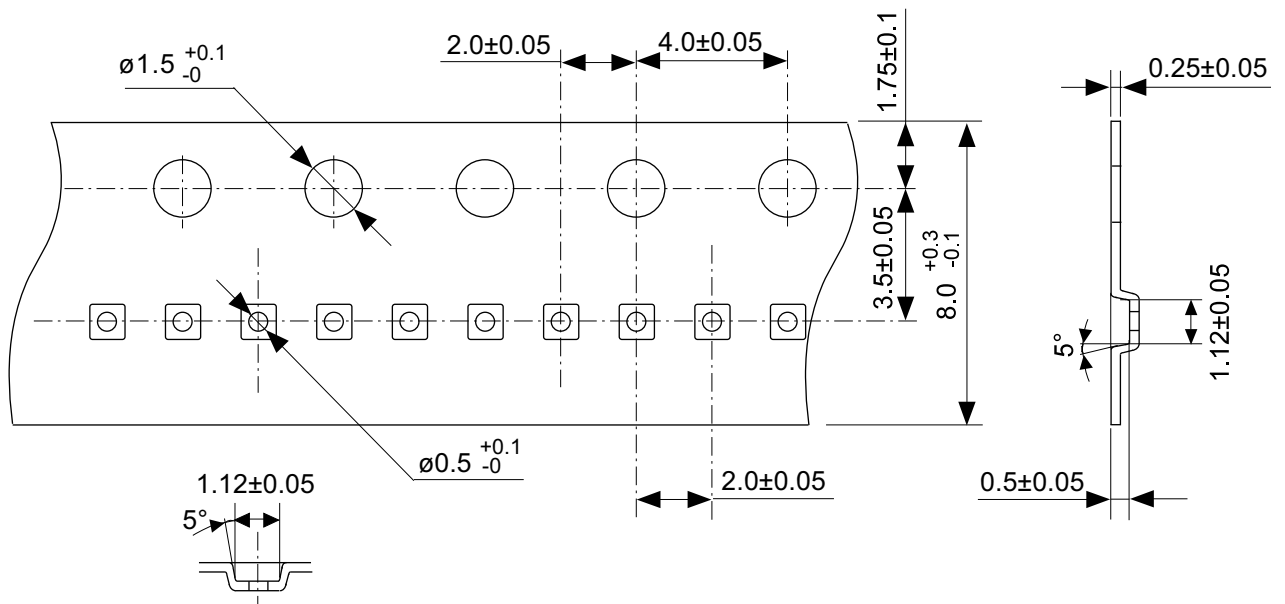

Feed direction →

No. PL004-A-C-SD-1.0

TITLE	HSNT-4-B-Carrier Tape
No.	PL004-A-C-SD-1.0
SCALE	
UNIT	mm
SII Semiconductor Corporation	



Enlarged drawing in the central part

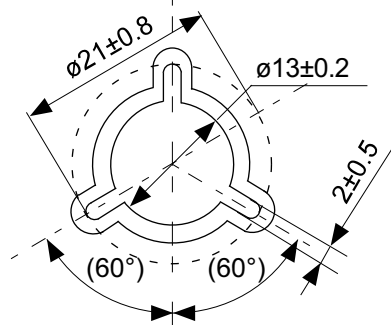

No. PL004-A-R-SD-1.0

TITLE	HSNT-4-B-Reel		
No.	PL004-A-R-SD-1.0		
SCALE		QTY.	10,000
UNIT	mm		
SII Semiconductor Corporation			

Land Pattern



Caution It is recommended to solder the heat sink to a board in order to ensure the heat radiation.

注意 放熱性を確保する為に、PKGの裏面放熱板(ヒートシンク)を基板に半田付けする事を推奨いたします。

Metal Mask Pattern

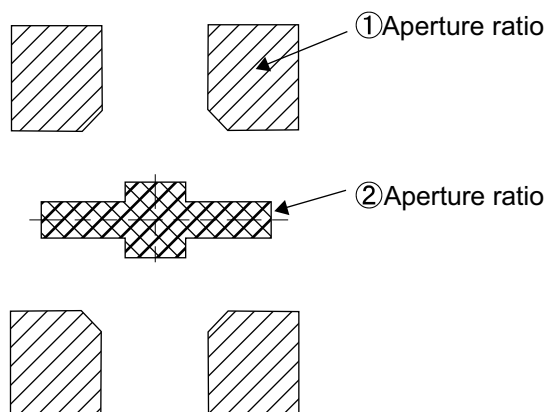

Caution ① Mask aperture ratio of the lead mounting part is 100%.
 ② Mask aperture ratio of the heat sink mounting part is 40%.
 ③ Mask thickness: t0.10mm to 0.12 mm

注意 ①リード実装部のマスク開口率は100%です。
 ②放熱板実装のマスク開口率は40%です。
 ③マスク厚み : t0.10mm ~ 0.12 mm

No. PL004-A-L-SD-2.0

TITLE	HSNT-4-B -Land Recommendation
No.	PL004-A-L-SD-2.0
SCALE	
UNIT	mm
SII Semiconductor Corporation	

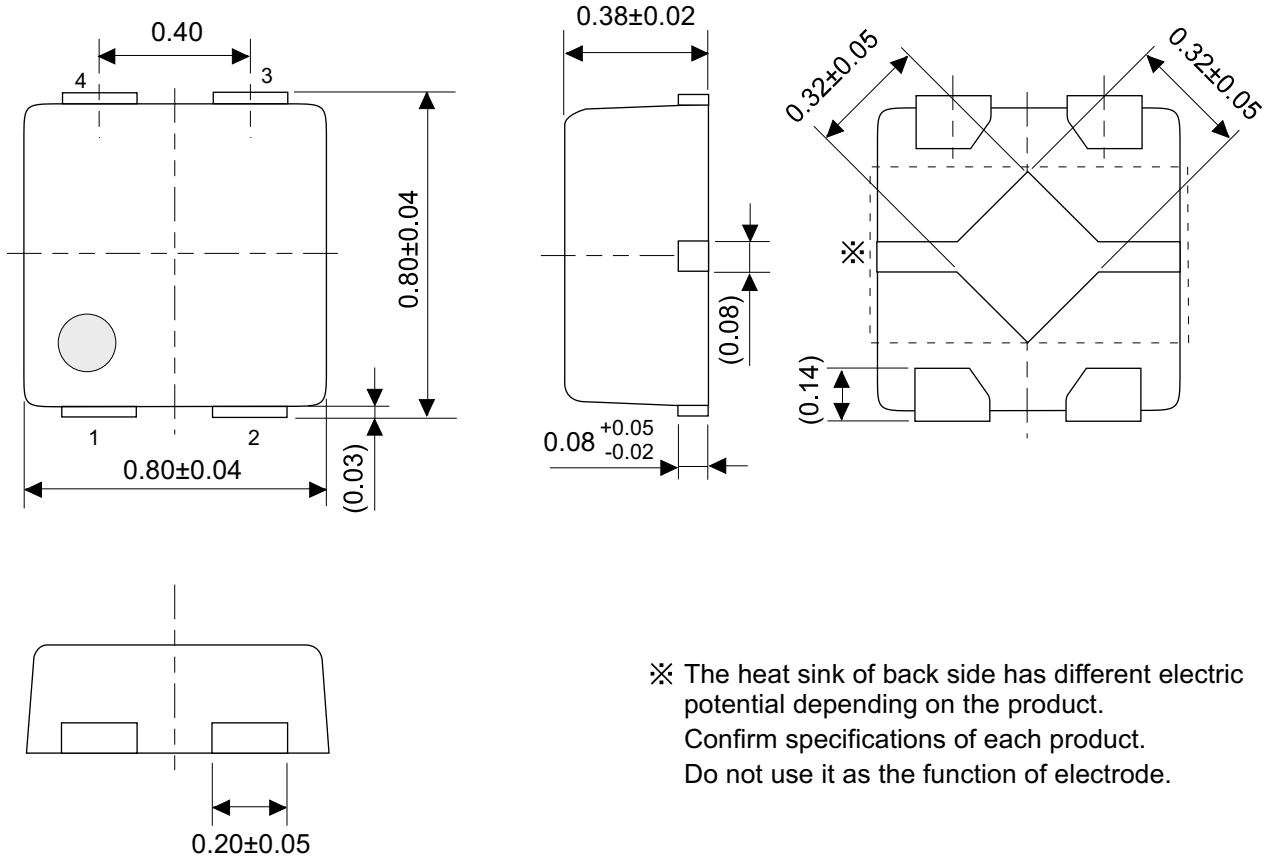

No. PK004-A-P-SD-2.0

TITLE	HSNT-4-A-PKG Dimensions
No.	PK004-A-P-SD-2.0
SCALE	
UNIT	mm
SII Semiconductor Corporation	

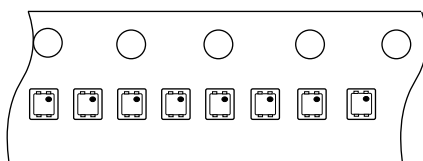
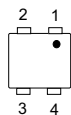
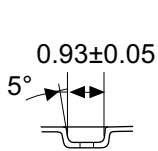
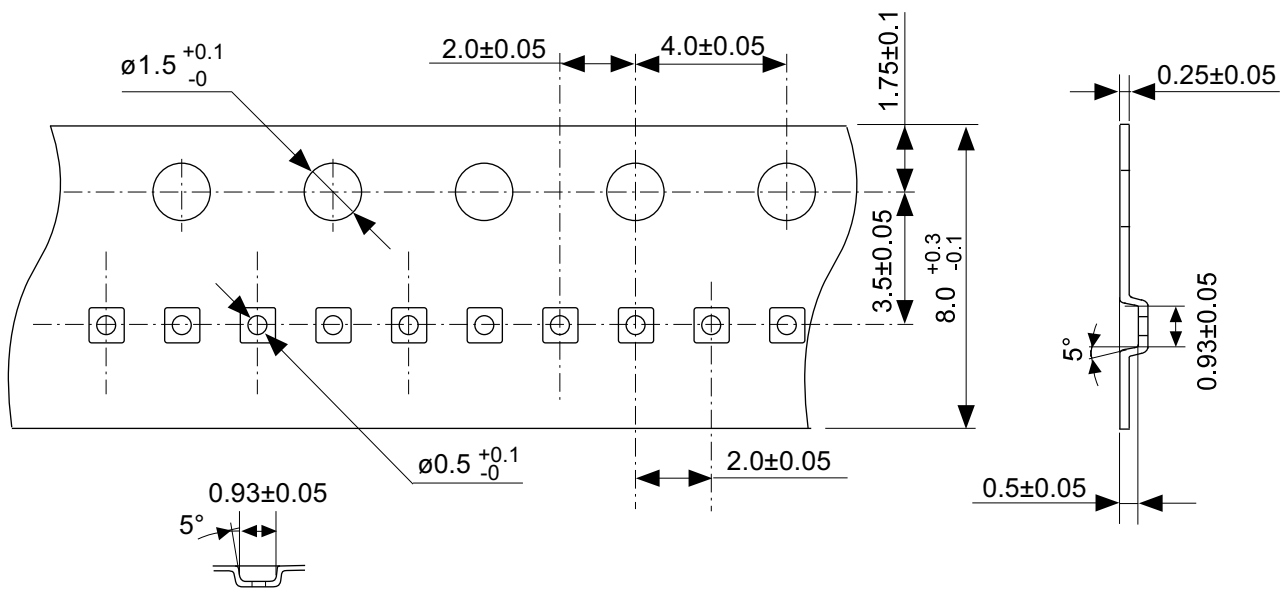

→
Feed direction

No. PK004-A-C-SD-2.0

TITLE	HSNT-4-A-Carrier Tape
No.	PK004-A-C-SD-2.0
SCALE	
UNIT	mm
SII Semiconductor Corporation	



Enlarged drawing in the central part

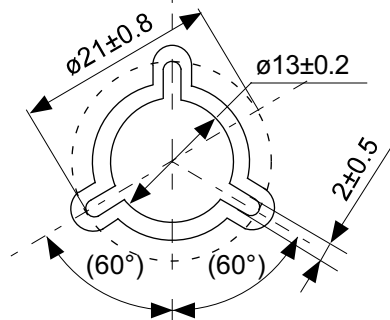

No. PK004-A-R-SD-2.0

TITLE	HSNT-4-A-Reel		
No.	PK004-A-R-SD-2.0		
SCALE		QTY.	10,000
UNIT	mm		
SII Semiconductor Corporation			

Land Pattern



Caution It is recommended to solder the heat sink to a board in order to ensure the heat radiation.

注意 放熱性を確保する為に、PKGの裏面放熱板(ヒートシンク)を基板に半田付けする事を推奨いたします。

Metal Mask Pattern



Caution ① Mask aperture ratio of the lead mounting part is 100%.
 ② Mask aperture ratio of the heat sink mounting part is 40%.
 ③ Mask thickness: t0.10mm to 0.12 mm

注意 ①リード実装部のマスク開口率は100%です。
 ②放熱板実装のマスク開口率は40%です。
 ③マスク厚み : t0.10mm ~ 0.12 mm

No. PK004-A-L-SD-3.0

TITLE	HSNT-4-A -Land Recommendation
No.	PK004-A-L-SD-3.0
SCALE	
UNIT	mm
SII Semiconductor Corporation	

免责声明 (使用注意事项)

1. 本资料记载的所有信息 (产品数据、规格、图、表、程序、算法、应用电路示例等) 是本资料公开时的最新信息, 有可能未经预告而更改。
2. 本资料记载的电路示例、使用方法仅供参考, 并非保证批量生产的设计。
使用本资料的信息后, 发生并非因产品而造成的损害, 或是发生对第三方知识产权等权利侵犯情况, 本公司对此概不承担任何责任。
3. 因本资料记载的内容有说明错误而导致的损害, 本公司对此概不承担任何责任。
4. 请注意在本资料记载的条件范围内使用产品, 特别请注意绝对最大额定值、工作电压范围和电气特性等。
因在本资料记载的条件范围外使用产品而造成的故障和 (或) 事故等的损害, 本公司对此概不承担任何责任。
5. 在使用本资料记载的产品时, 请确认使用国家、地区以及用途的法律、法规, 测试产品用途的满足能力和安全性能。
6. 本资料记载的产品出口海外时, 请遵守外汇交易及外国贸易法等出口法令, 办理必要的相关手续。
7. 严禁将本资料记载的产品用于以及提供 (出口) 于开发大规模杀伤性武器或军事用途。对于如提供 (出口) 给开发、制造、使用或储藏核武器、生物武器、化学武器及导弹, 或有其他军事目的者的情况, 本公司对此概不承担任何责任。
8. 本资料记载的产品并非是设计用于可能对人体、生命及财产造成损失的设备或装置的部件 (医疗设备、防灾设备、安全防范设备、燃料控制设备、基础设施控制设备、车辆设备、交通设备、车载设备、航空设备、太空设备及核能设备等)。本公司指定的车载用途例外。上述用途未经本公司的书面许可不得使用。本资料所记载的产品不能用于生命维持装置、植入人体使用的设备等直接影响人体生命的设备。考虑使用于上述用途时, 请务必事先与本公司营业部门商谈。
本公司指定用途以外使用本资料记载的产品而导致的损害, 本公司对此概不承担任何责任。
9. 半导体产品可能有一定的概率发生故障或误工作。
为了防止因本公司产品的故障或误工作而导致的人身事故、火灾事故、社会性损害等, 请客户自行负责进行冗长设计、防止火势蔓延措施、防止误工作等安全设计。并请对整个系统进行充分的评价, 客户自行判断适用的可否。
10. 本资料记载的产品非耐放射线设计产品。请客户根据用途, 在产品设计的过程中采取放射线防护措施。
11. 本资料记载的产品在一般的使用条件下, 不会影响人体健康, 但因含有化学物质和重金属, 所以请不要将其放入口中。
另外, 晶元和芯片的破裂面可能比较尖锐, 徒手接触时请注意防护, 以免受伤等。
12. 废弃本资料记载的产品时, 请遵守使用国家和地区的法令, 合理地处理。
13. 本资料中也包含了与本公司的著作权和专有知识有关的内容。
本资料记载的内容并非是对本公司或第三方的知识产权、其它权利的实施及使用的承诺或保证。严禁在未经本公司许可的情况下转载或复制这些著作物的一部分, 向第三方公开。
14. 有关本资料的详细内容, 请向本公司营业部门咨询。

1.0-2016.01