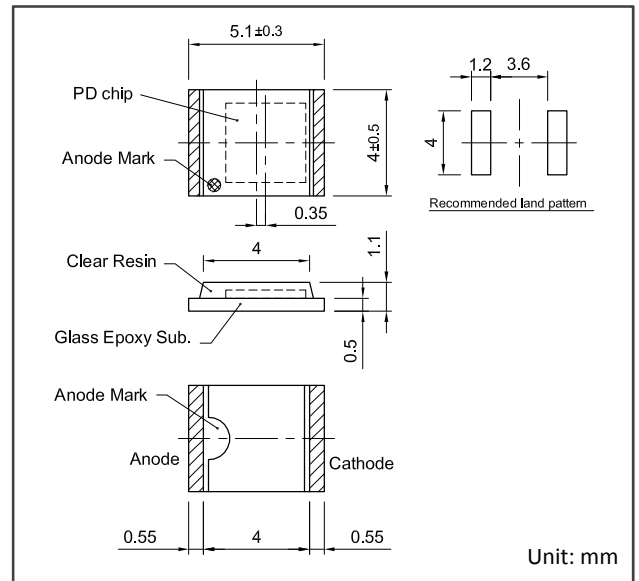

Features

- Transparent epoxy mold
- High sensitivity
- SMD package

Applications

- Optical switches
- Optical encoders
- Pulse detectors
- Sensors and industrial controls

**Absolute Maximum Ratings**

Parameter	Symbol	Value	Unit	Note
Reverse voltage	V_R	10	V	
Reverse current	I_R	1	mA	
Forward current	I_F	10	mA	
Operating temperature	T_{opr}	-20 to +80	°C	Avoid dew condensation
Storage temperature	T_{stg}	-30 to +85	°C	Avoid dew condensation
Soldering temperature	T_{sol}	260	°C	Max 3 sec.

Electrical and Optical Characteristics (Ta=25°C unless otherwise noted)

Parameter	Symbol	Min.	Typ.	Max.	Unit	Test Condition
Active area	S	2.59 x 2.59			mm ²	
Sensitive wavelength	λ	400	950(λ_p)	1100	nm	λ_p =Peak wavelength
Open circuit voltage	V_{op}	-	350	-	mV	1000lx @2856K
Short circuit current	I_{sh}	-	68	-	μ A	1000lx @2856K
Dark current	I_D	-	-	30	nA	$V_R=5V$
Terminal capacitance	C_t	-	30	-	pF	$V_R=5V, f=1MHz$
Half angle	2θ	-	120	-	deg.	

Dark Current - Reverse Voltage

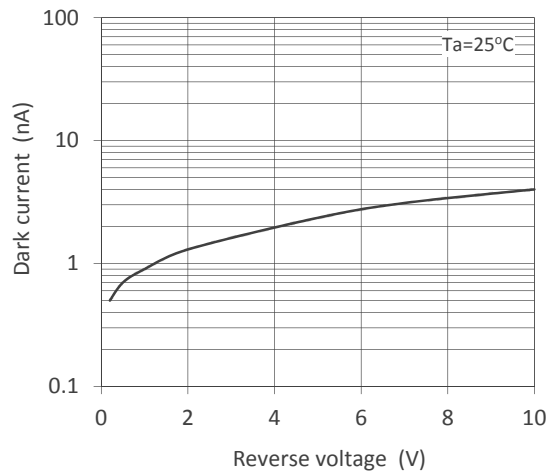

Photocurrent - Ambient Temperature

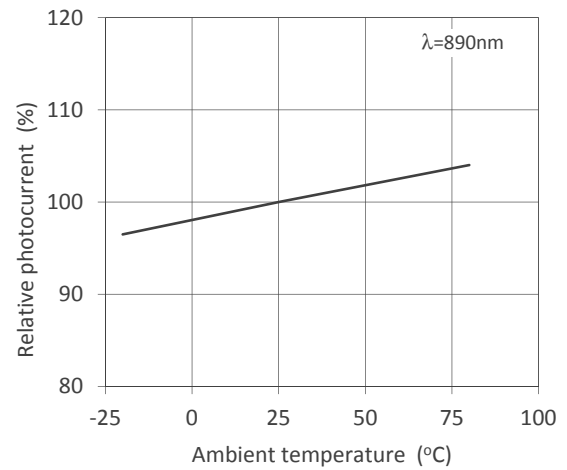

Photocurrent - Illuminance

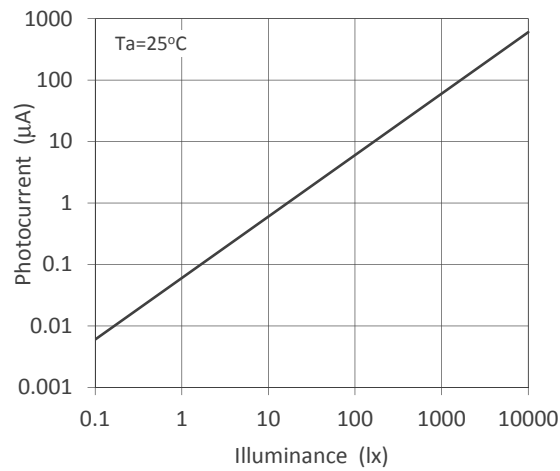

Dark Current - Ambient Temperature

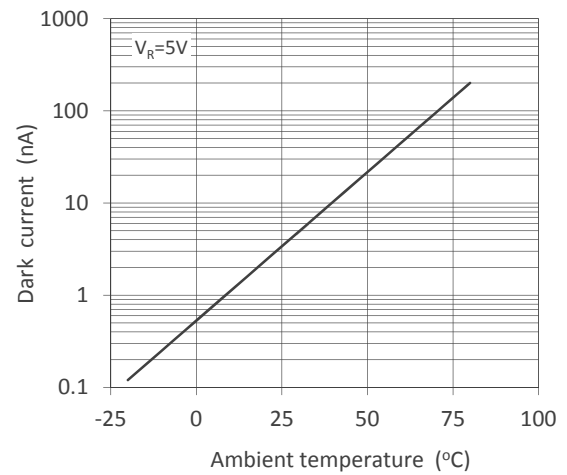

Spectral Responsivity

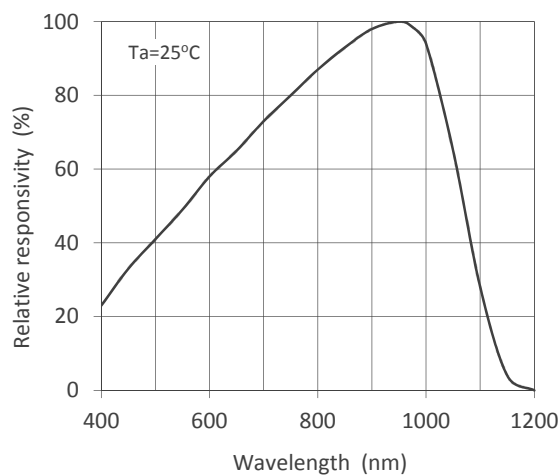

Directivity

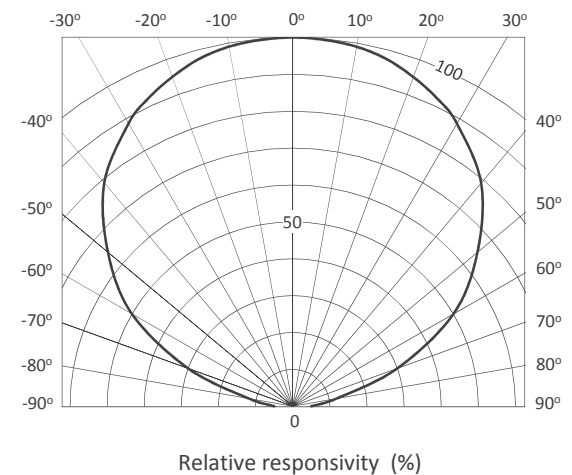

- Specifications, characteristics, data, materials, structures specified in this datasheet are subject to change without notice. Please refer to the latest specification before use of the products.
- Products listed in this datasheet comply with the RoHS Directive (EU2002/95/EC).

Opto-technologies for the Future



KYOSEMI CORPORATION

<http://www.kyosemi.co.jp/>

Headquarters : 949-2 Ebisucho Fushimi-ku, Kyoto 612-8201 Japan

TEL: +81-75-605-7311

Tokyo Sales Office: 24th Sky Bldg.2F, 1-34-3 Shinjuku Shinjuku-ku, Tokyo 160-0022 Japan

TEL: +81-3-5312-5360

Kansai Sales Office: 949-2 Ebisucho Fushimi-ku, Kyoto 612-8201 Japan

TEL: +81-75-605-7311

Kyosemi Opto America Corp: 4655 Old Ironsides Suite 230 Santa Clara, California 95054 USA

TEL: +1-408-492-9361

Eniwa Operation: 385-31 Toiso Eniwa-shi, Hokkaido 061-1405 Japan

TEL: +81-123-34-3111

Kamisunagawa Operation: 70-1 Kamisunagawa Kamisunagawa-cho Sorachi-gun, Hokkaido 073-0200 Japan

TEL: +81-125-62-3611