

# Plastic Mold Infrared LEDs KED861M32

## Features

- Transparent epoxy mold
- High power:22mW
- High speed response:25ns rise time
- Direct modulation

## Applications

- Available for wireless digital transmission
- Optical switches
- Optical encoders
- Optical instruments
- Automatic control apparatus

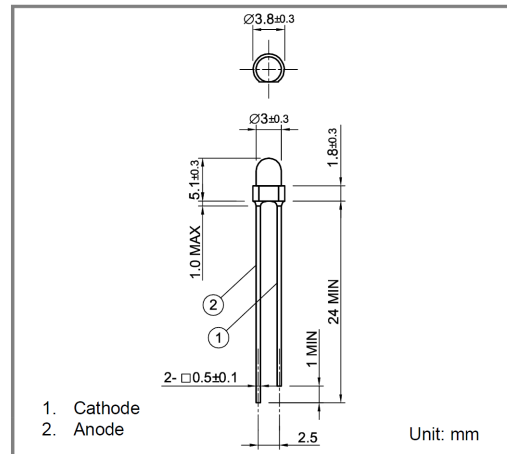

## Specifications

### Absolute Maximum Ratings

Parameter	Symbol	Value	Unit	Conditions
Forward current	$I_F$	100	mA	
Peak forward current	$I_{FP}$	1	A	Puls width=100 $\mu$ s, Duty ratio=1%
Reverse voltage	$V_R$	5	V	
Power dissipation	$P_D$	150	mW	
Operating temperature	$T_{opr}$	-30 to +85		Avoid dew condensation
Storage temperature	$T_{stg}$	-30 to +100		Avoid dew condensation
Soldering temperature	$T_{sol}$	260		Soldering time less than 5 seconds

### Electrical and Optical characteristics

Parameter	Symbol	Value			Unit	Conditions
		Min.	Typ.	Max		
Forward voltage	$V_F$		1.5	1.8	V	$I_F=50$ mA
Reverse Current	$I_R$			10	$\mu$ A	$V_R=5$ V
Optical output power	$P_O$		22		mW	$I_F=50$ mA
Peak wavelength	$\rho$		865		nm	$I_F=50$ mA
Spectral width			40		nm	$I_F=50$ mA
Half angle	2		50		deg	$I_F=50$ mA
Rise time	$t_r$		25		ns	$I_F=50$ mA
Fall time	$t_f$		15		ns	$I_F=50$ mA

