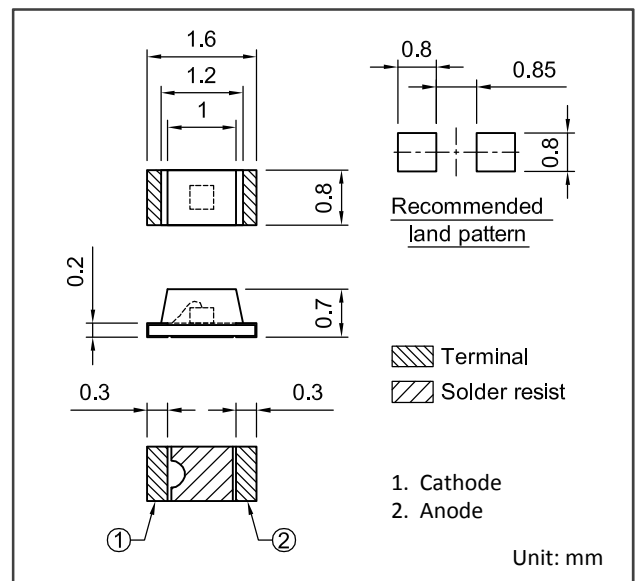

**Features**

- 660nm AlGaInP Red LED mounted
- SMD type package
- Transparent epoxy mold

**Applications**

- Optical instruments

**Absolute Maximum Ratings**

Parameter	Symbol	Value	Unit	Note
Forward current	$I_F$	50	mA	$T_a=25^\circ\text{C}$
Peak forward current	$I_{FP}$	0.5	A	Pulse width=100 $\mu\text{s}$ Duty ratio=0.1%
Reverse voltage	$V_R$	5	V	
Power dissipation	$P_D$	130	mW	$T_a=25^\circ\text{C}$
Operating temperature	$T_{opr}$	-20 to +80	$^\circ\text{C}$	Avoid dew condensation
Storage temperature	$T_{stg}$	-25 to +100	$^\circ\text{C}$	Avoid dew condensation

**Electrical and Optical Characteristics** ( $T_a=25^\circ\text{C}$  unless otherwise noted)

Parameter	Symbol	Min.	Typ.	Max.	Unit	Test Condition
Forward voltage	$V_F$	-	2.0	2.6	V	$I_F=20\text{mA}$
Reverse current	$I_R$	-	-	10	$\mu\text{A}$	$V_R=5\text{V}$
Optical output power	$P_O$	-	14	-	mW	$I_F=20\text{mA}$
Peak emission wavelength	$\lambda_p$	650	660	670	nm	$I_F=20\text{mA}$
Spectral bandwidth at 50%	$\Delta\lambda$	-	20	-	nm	$I_F=20\text{mA}$
Half angle	$2\theta$	-	145	-	deg.	

Allowable Forward Current-Ambient Temperature

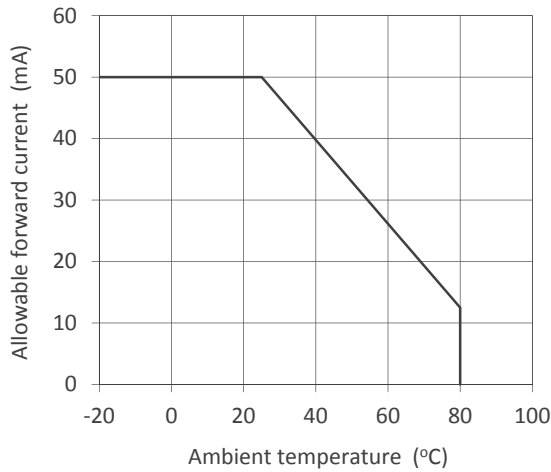

Optical Output Power - Forward Current

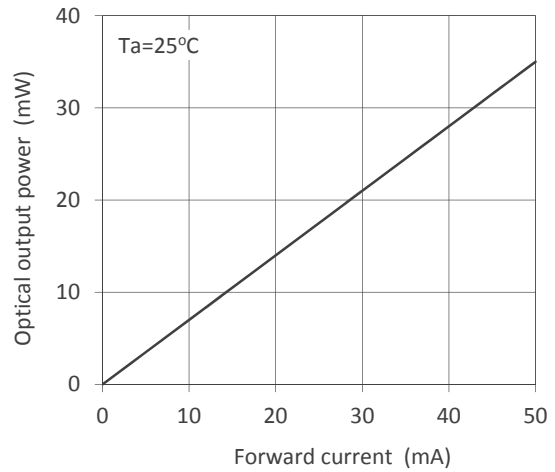

Forward Current - Forward Voltage

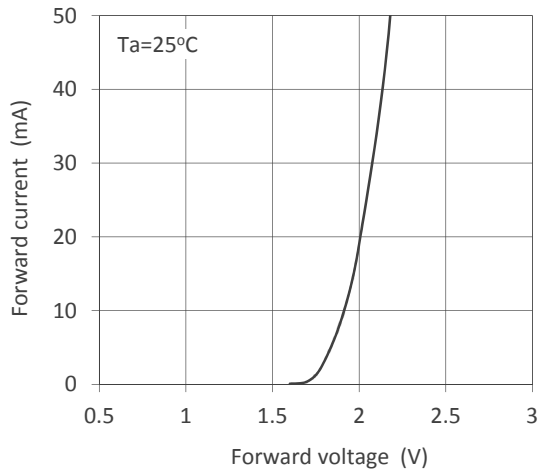

Relative Optical Output Power - Ambient Temperature

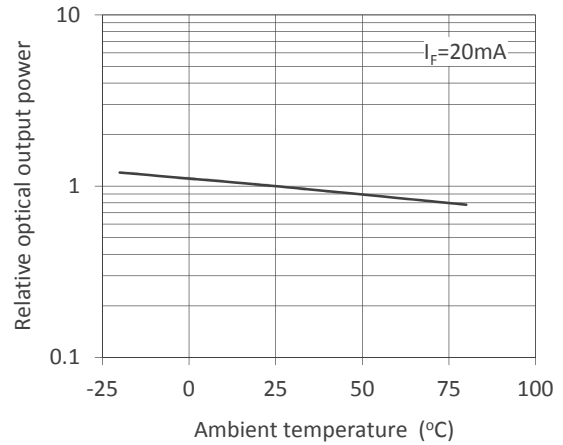

Spectral Distribution

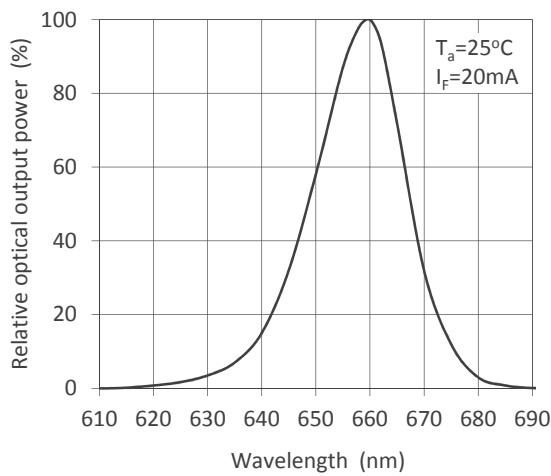

Directivity

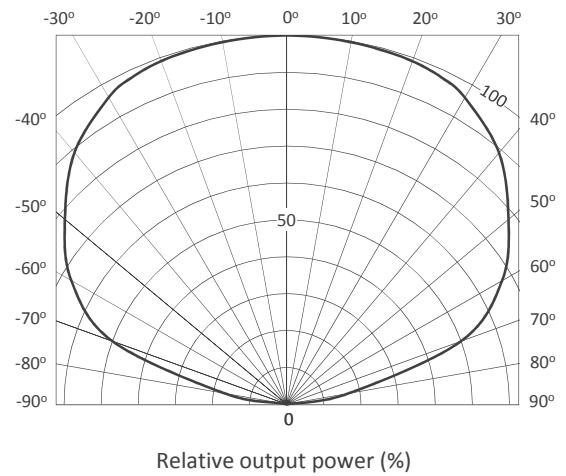

- Specifications, characteristics, data, materials, structures specified in this datasheet are subject to change without notice. Please refer to the latest specification before use of the products.
- Products listed in this datasheet comply with the RoHS Directive (EU2002/95/EC).

**Opto-technologies for the Future**



---

## KYOSEMI CORPORATION

<http://www.kyosemi.co.jp/>

**Headquarters :** 949-2 Ebisucho Fushimi-ku, Kyoto 612-8201 Japan

TEL: +81-75-605-7311

**Tokyo Sales Office:** 24<sup>th</sup> Sky Bldg.2F, 1-34-3 Shinjuku Shinjuku-ku, Tokyo 160-0022 Japan

TEL: +81-3-5312-5360

**Kansai Sales Office:** 949-2 Ebisucho Fushimi-ku, Kyoto 612-8201 Japan

TEL: +81-75-605-7311

**Kyosemi Opto America Corp:** 4655 Old Ironsides Suite 230 Santa Clara, California 95054 USA

TEL: +1-408-492-9361

**Eniwa Operation:** 385-31 Toiso Eniwa-shi, Hokkaido 061-1405 Japan

TEL: +81-123-34-3111

**Kamisunagawa Operation:** 70-1 Kamisunagawa Kamisunagawa-cho Sorachi-gun, Hokkaido 073-0200 Japan

TEL: +81-125-62-3611