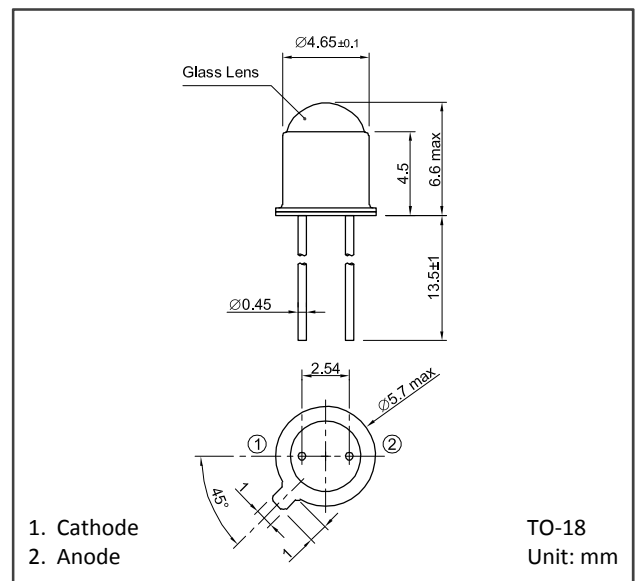

Features

- High power with a double heterojunction
- Highly reliable hermetic seal
- Sharp directivity with a glass lens
- Direct modulation

Application

- Optical switches
- Optical encoders
- Optical instruments
- Automatic control apparatus

**Absolute Maximum Ratings**

Parameter	Symbol	Value	Unit	Note
Forward current	I_F	50	mA	Ta=25°C
Peak forward current	I_{FP}	0.5	A	Pulse width=100μs Duty ratio=0.1%
Reverse voltage	V_R	6	V	
Power dissipation	P_D	100	mW	Ta=25°C
Operating temperature	T_{opr}	-40 to +100	°C	Avoid dew condensation
Storage temperature	T_{stg}	-55 to +125	°C	Avoid dew condensation

Electrical and Optical Characteristics (Ta=25°C unless otherwise noted)

Parameter	Symbol	Min.	Typ.	Max.	Unit	Test condition
Forward voltage	V_F	-	1.8	2.3	V	$I_F=20\text{mA}$
Reverse current	I_R	-	-	10	μA	$V_R=6\text{V}$
Optical output power	P_O	-	1.8	-	mW	$I_F=20\text{mA}$
Peak emission wavelength	λ_p	-	660	-	nm	$I_F=20\text{mA}$
Spectral bandwidth at 50%	$\Delta\lambda$	-	20	-	nm	$I_F=20\text{mA}$

Allowable Forward Current-Ambient Temperature

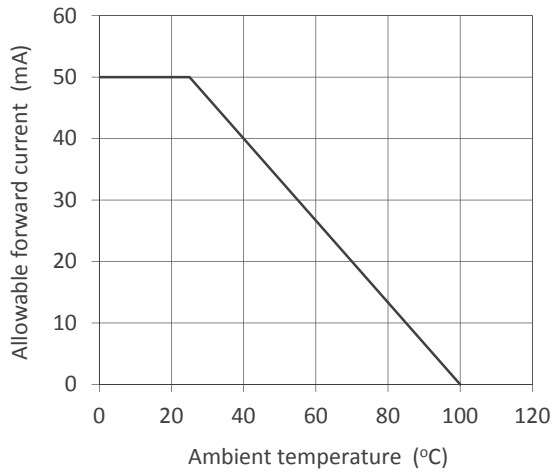

Optical Output Power - Forward Current

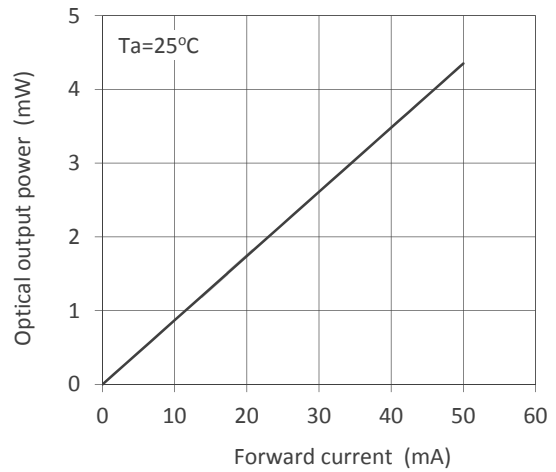

Forward Current - Forward Voltage

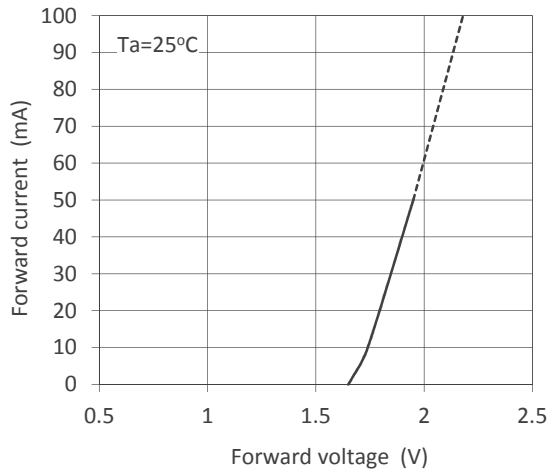

Relative Optical Output Power - Ambient Temperature

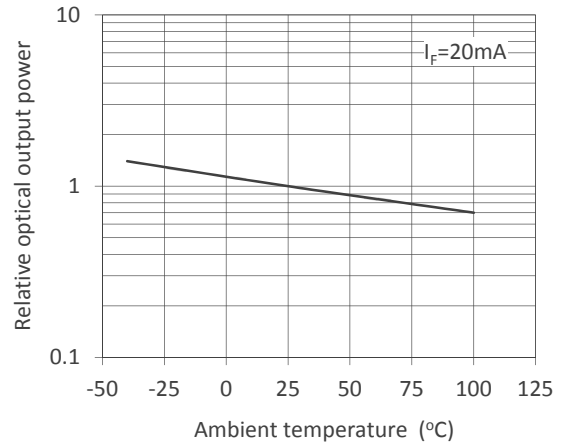

Spectral Distribution

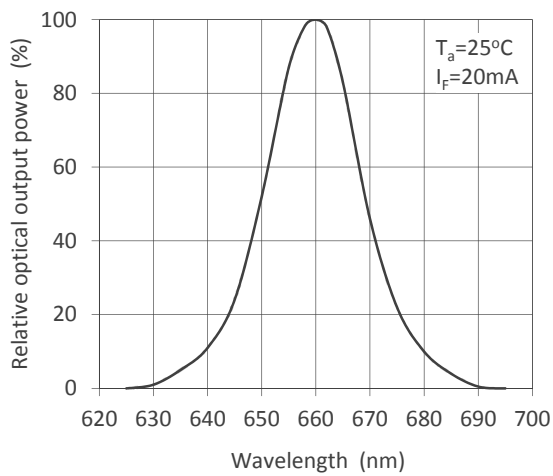

Directivity

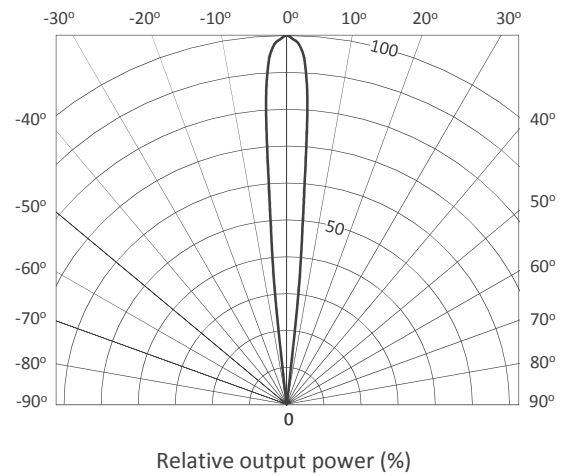

- Specifications , characteristics, data, materials, structures specified in this datasheet are subject to change without notice. Please refer to the latest specification before use of the products.
- Products listed in this datasheet comply with the RoHS Directive (EU2002/95/EC).

Opto-technologies for the Future



KYOSEMI CORPORATION

<http://www.kyosemi.co.jp/>

Headquarters : 949-2 Ebisucho Fushimi-ku, Kyoto 612-8201 Japan

TEL: +81-75-605-7311

Tokyo Sales Office: 24th Sky Bldg.2F, 1-34-3 Shinjuku Shinjuku-ku, Tokyo 160-0022 Japan

TEL: +81-3-5312-5360

Kansai Sales Office: 949-2 Ebisucho Fushimi-ku, Kyoto 612-8201 Japan

TEL: +81-75-605-7311

Kyosemi Opto America Corp: 4655 Old Ironsides Suite 230 Santa Clara, California 95054 USA

TEL: +1-408-492-9361

Eniwa Operation: 385-31 Toiso Eniwa-shi, Hokkaido 061-1405 Japan

TEL: +81-123-34-3111

Kamisunagawa Operation: 70-1 Kamisunagawa Kamisunagawa-cho Sorachi-gun, Hokkaido 073-0200 Japan

TEL: +81-125-62-3611